

# Ford 5R55W/S

# sonnax®

TIME TESTED • INDUSTRY TRUSTED®

1 Automatic Drive • P.O. Box 440 • Bellows Falls, VT 05101-0440 USA  
(800) 843-2600 • (802) 463-9722 • F: (802) 463-4059 • www.sonnax.com

Click on Sonnax part numbers to see more information.

**1 56947J-05K\***  
**Oversized TCC Control Valve Kit**

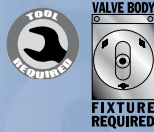

*Helps cure:*

- Excess TCC slip
- Code 741

**Note:** Requires tool kit **F-56947J-TL2** & the **VB-FIX** reaming fixture.

**2 56947J-15K\***  
**TCC Modulator Valve Kit**

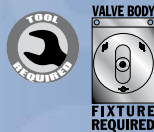

*Helps cure:*

- Excess TCC slip
- Codes 741 & 1783

**Note:** Requires tool kit **F-56947J-TL15** & the **VB-FIX** reaming fixture.

**3 56947J-03K** Increased Ratio  
**56947J-01K** OE Ratio  
**TCC Modulator Plunger Valve Kit**

*Helps cure:*

- High TCC slip RPM at increasing load
- Slip codes

**4 56947J-09K**  
**Pressure Regulator Sleeve Kit**



*Helps cure:*

- Delayed engagements
- High line pressure in reverse

**Note:** Requires tool kit **56947J-TL9**.

**5 56947J-26K**  
**Oversized Forward Engagement Valve Kit**

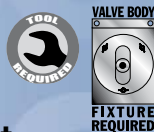

*Helps cure:*

- Slipping/Loss of forward gears
- Burned forward clutch

**Note:** Requires tool kit **F-27741-TL13** & the **VB-FIX** reaming fixture.

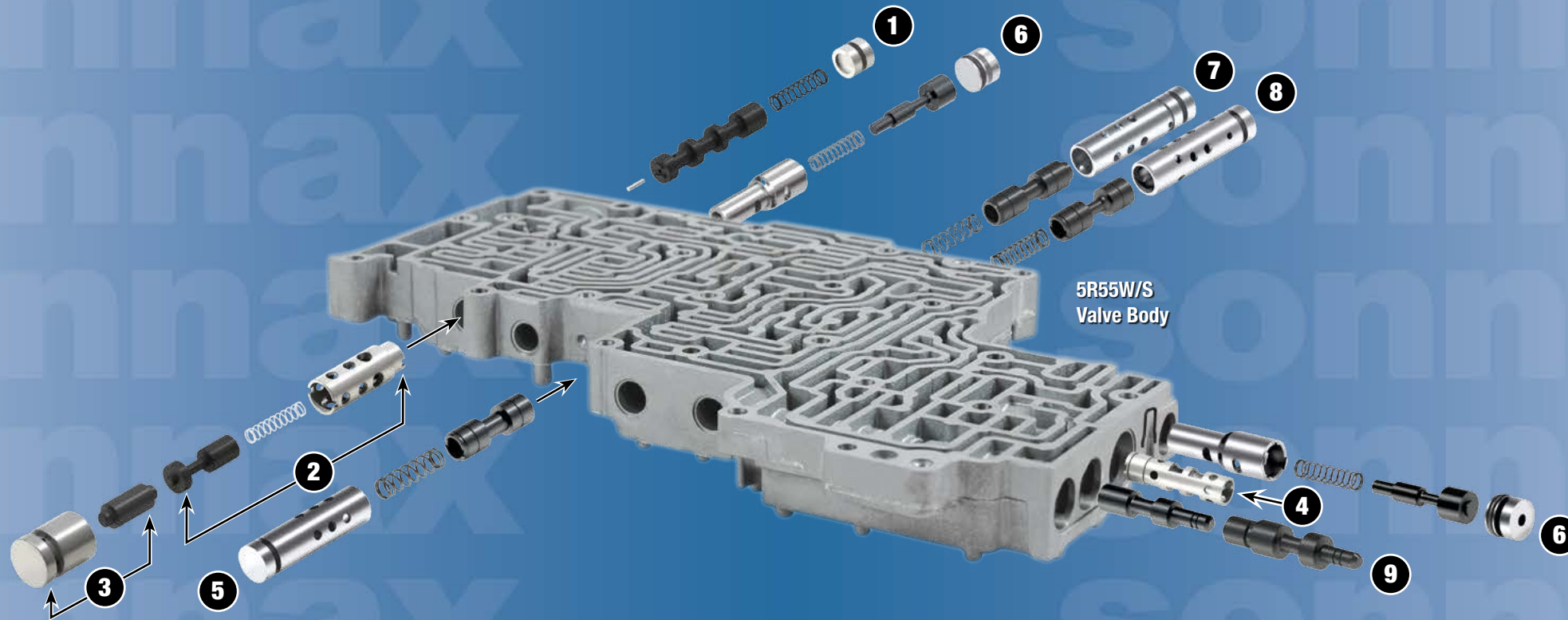

5R55W/S Valve Body

**6 56947J-19K**  
**Oversized VFS Modulator Control Valve Kit**

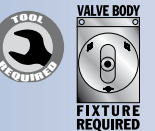

Fits either of 2 locations

*Helps cure:*

- Line pressure concerns
- Slipping upshifts

**Note:** Requires tool kit **F-56947J-TL19** & the **VB-FIX** reaming fixture.

**7 56947J-23K**  
**Oversized Reverse Modulator Valve Kit**

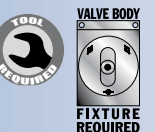

*Helps cure:*

- Delayed reverse
- Loss of 4th or 5th

**Note:** Requires tool kit **F-27741-TL13** & the **VB-FIX** reaming fixture.

**8 56947J-29K**  
**Reverse Engagement Valve Kit**

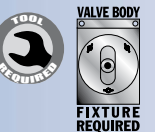

*Helps cure:*

- Slipping/Loss of reverse
- Burned direct clutch

**Note:** Requires tool kit **F-27741-TL13** & the **VB-FIX** reaming fixture.

**9 56947J-61K**  
**Oversized Solenoid & Converter Feed Limit Valve Kit**

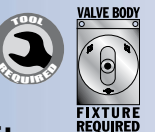

*Helps cure:*

- Gear ratio codes 731 to 741
- No TCC apply

**Note:** Requires tool kit **F-56947J-TL61** & the **VB-FIX** reaming fixture.

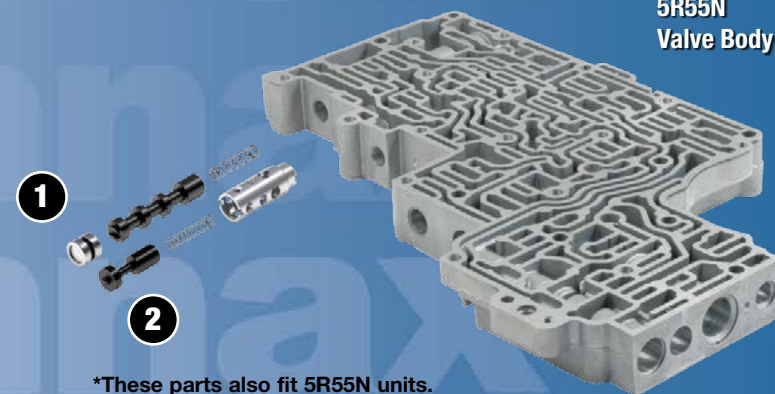

5R55N Valve Body

\*These parts also fit 5R55N units.