

# Aisin AW TF-60SN\*

\*Also fits Mini 6F21WA & VW/Audi 09G, 09K, 09M units

## 1 15741-29K Lockup Clutch Control Valve Kit

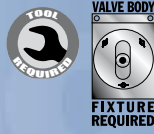

Helps cure:

- RPM surge on coast/light acceleration
- Harsh downshifts

Note: Requires tool kits F-15741-TL29, F-15741-TL29PL & the VB-FIX reaming fixture.

## 2 15741-53K Lockup Clutch Control Plunger Valve Kit

Helps cure:

- TCC apply & release concerns/TCC codes
- RPM surge on coast/light acceleration

## 3 15741-01K Oversized Pressure Reg- ulator & Boost Valve Kit



Helps cure:

- High line pressure in Reverse
- Overheated fluid & TCC lining

Note: Requires tool kit F-15741-TL & the VB-FIX reaming fixture.

## 4 15741-11K Secondary Pressure Regulator Valve Kit

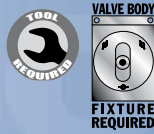

Helps cure:

- Overheated fluid, bushing & converter
- Harsh Reverse

Note: Requires tool kit F-15741-TL11 & the VB-FIX reaming fixture.

## 5 15741-18K Solenoid Modulator Valve Kit

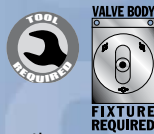

Helps cure:

- Kickdown slip/shock
- 4th/5th/6th Slip

Note: Requires tool kits F-15741-TL18, F-15741-TL29PL & the VB-FIX reaming fixture.

## 6 15741-41 Oversized Manual Valve



Helps cure:

- Low line pressure
- Delayed engagement

Note: Requires tool kit F-15741-TL41 & the VB-FIX reaming fixture.

## 7 15741-51K Boost Valve Kit

Helps cure:

- Delayed Reverse
- Low line rise in Reverse

## 8 15741-25K Valve/Sleeve/Spring 15741-55K Oversized Valve/Spring C1/K1 Clutch Control Valve Kit



Helps cure:

- Flare/Harsh shifts
- Gear ratio & solenoid codes

Note: 15741-25K requires tool kit F-15741-TL25, 15741-55K requires tool kit F-15741-TL55 & they both require VB-FIX reaming fixture.

## 9 15741-05K Valve/Sleeve/Spring 15741-57K Oversized Valve/Spring K2 Clutch Control Valve Kit



Helps cure:

- Flare/Harsh shifts
- Gear ratio & solenoid codes

Note: 15741-05K requires tool kit F-15741-TL5, 15741-57K requires tool kit F-15741-TL57 & they both require VB-FIX reaming fixture.

## 10 15741-08K Valve/Sleeve/Spring 15741-59K Oversized Valve/Spring K3 Clutch Control Valve Kit

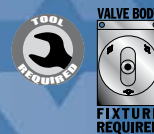

Helps cure:

- Flare/Harsh shifts
- Gear ratio & solenoid codes

Note: 15741-08K requires tool kit F-15741-TL8, 15741-59K requires tool kit F-15741-TL59 & they both require VB-FIX reaming fixture.

# sonnax®

TIME TESTED • INDUSTRY TRUSTED®

1 Automatic Drive • P.O. Box 440 • Bellows Falls, VT 05101-0440 USA  
(800) 843-2600 • (802) 463-9722 • F: (802) 463-4059 • www.sonnax.com

## 11 15741-63K Fits Any of 3 Locations Oversized Clutch Cutoff Valve Kit

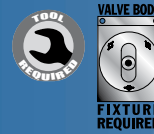

Helps cure:

- Burnt clutches
- Overheated fluid
- Harsh/Soft shifts
- Erratic shift timing

Note: Requires tool kit F-15741-TL63 & the require VB-FIX reaming fixture.

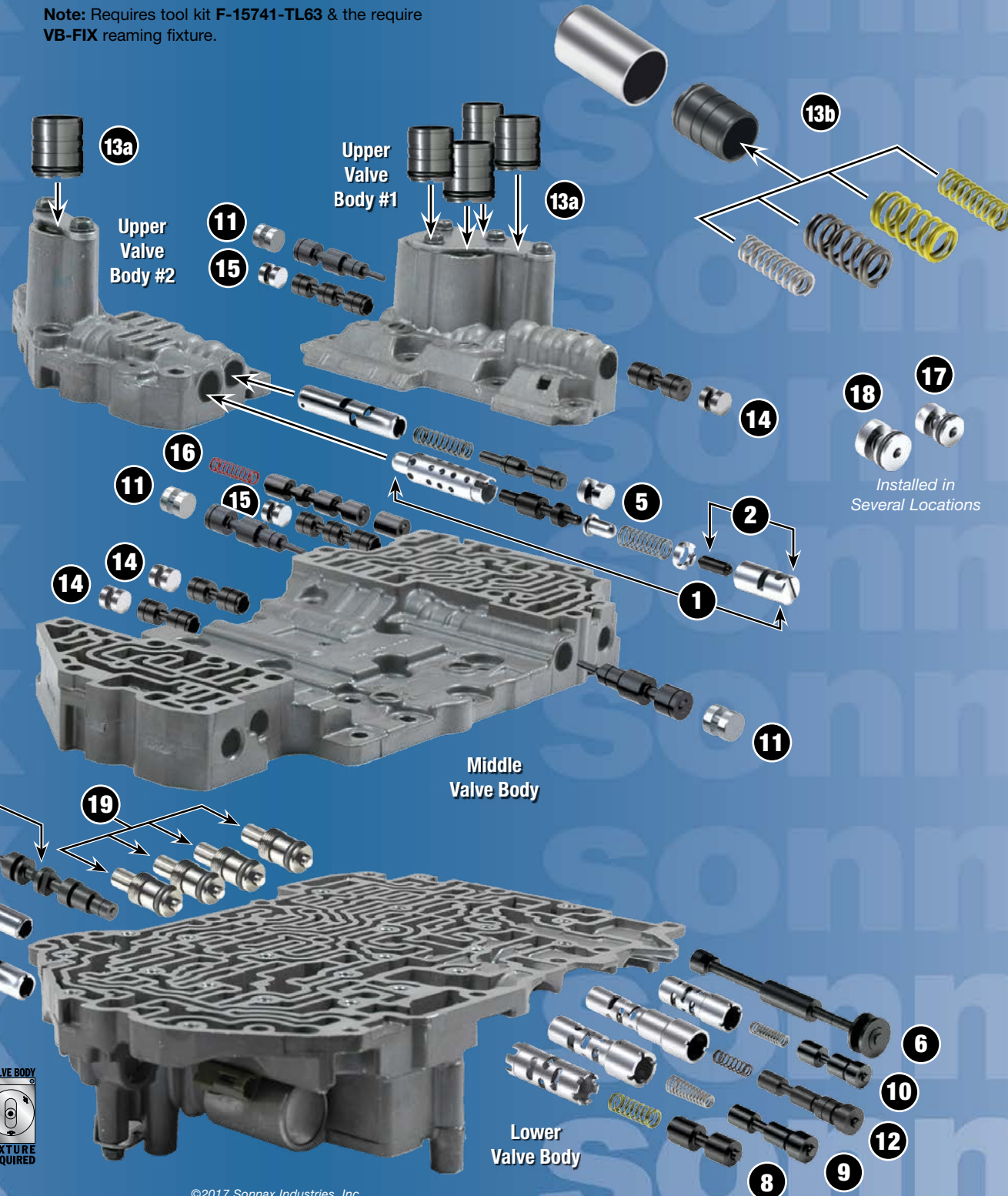

## 12 15741-22K Valve/Sleeve/Spring 15741-61K Oversized Valve/Spring B1 Clutch Control Valve Kit



Helps cure:

- Harsh shifts
- 2nd/6th Slip
- 1-2/5-6 Flare
- B1 Clutch burned

Note: 15741-22K requires tool kit F-15741-TL22, 15741-61K requires tool kit F-15741-TL61 & they both require VB-FIX reaming fixture.

## 13a 15741-14K Fits Any of 5 Locations Accumulator Piston Kit

Helps cure:

- Delayed engagement
- Forward slip
- Burnt clutches/bands

## 13b 39741-42K Fits Any of 5 Locations Accumulator Piston Kit

Helps cure:

- Severe wear at accumulator bores
- Loss clutch oil pressure
- Low TCC/EPC pressure

## 14 15741-49K Fits Any of 3 Locations Oversized Two-Spool Relay/Signal Valve Kit

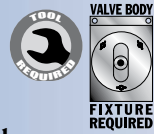

Helps cure:

- Gear ratio & solenoid codes
- No shift/various shift concerns

Note: Requires tool kit F-33741B-TL1 & the VB-FIX reaming fixture.

## 15 15741-50K Fits Any of 2 Locations Oversized Three-Spool Relay/Control/Switch Valve Kit

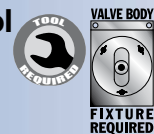

Helps cure:

- Gear ratio & solenoid codes
- No shifts/various shift concerns

Note: Requires tool kit F-33741B-TL1 & the VB-FIX reaming fixture.

## 16 15741-70K Oversized Main Relay Valve Kit

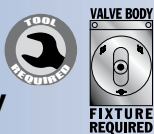

Helps cure:

- Gear ratio & solenoid codes
- No 4th/5th/6th

Note: Requires tool kit F-15741-TL70 & the VB-FIX reaming fixture.

## 17 15741-35K 5 Small, 9mm

## 18 15741-36K 5 Large, 11mm

### O-Ringed End Plug Kit

Helps cure:

- Shift concerns associated with circuit pressure loss

Note: These kits fit multiple locations.

## 19 15741-48K Fits 4 Locations Spring Adjuster Kit



Helps cure:

- Soft/Long/Flare shifts
- Intermediate clutch/solenoid codes