

Forward Clutch Hub Washer (Rear)

Part No.

34301-094

Washers (5) .094" Thick

Sonnax Front Unit Endplay		
Part Number	Shim Thickness	
34301-078	.078"	
34301-094	.094"	
GM Front Unit Endplay		
OE Shims	Color	Number
.060" – .064"	Yellow	0
.071" – .075"	Blue	1
.082" – .086"	Red	2
.093" – .097"	Brown	3
.104" – .108"	Green	4
.115" – .119"	Black	5
.126" – .130"	Purple	6

Sonnax Front Unit Endplay		
Part Number	Shim Thickness	
34500-Z	.010"	
GM Rear Unit Endplay		
OE Shims	I.D. Notch	Number
.074" – .078"	None	1
.082" – .086"	*1 tab	2
.090" – .094"	*2 tabs	3
.098" – .102"	*3 tabs	4
.105" – .110"	*4 tabs	5
.114" – .118"	*5 tabs	6

*Place on the side of tabs.

GM TH400, 4L80-E, 4L85-E

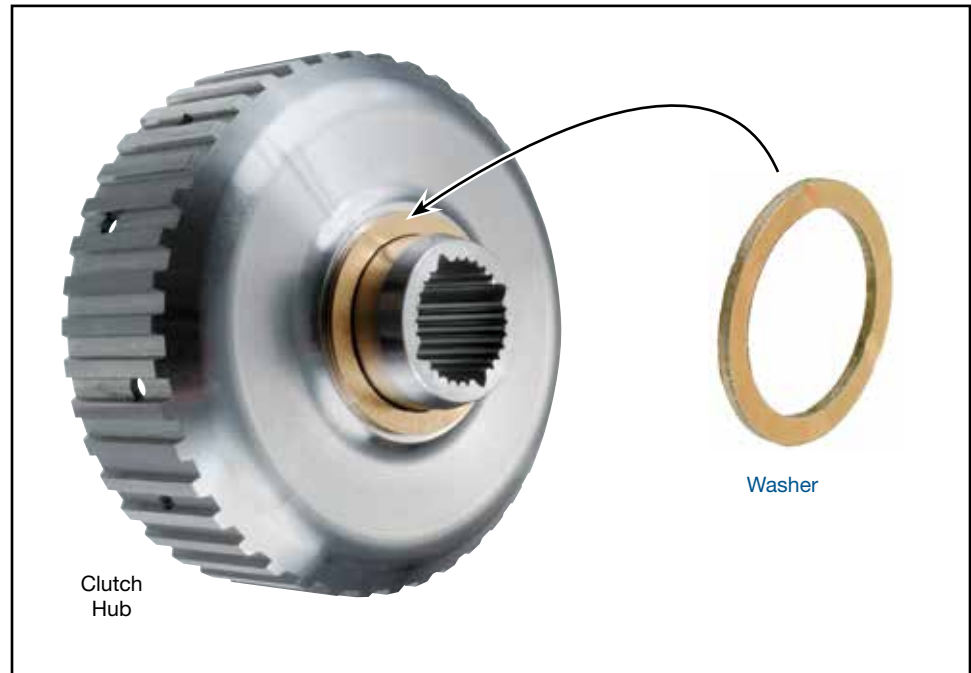

1. THM 400 Front Unit Endplay

- Place dial indicator on input shaft, preload shaft inward, zero-out indicator, and pull shaft outward to measure endplay.
- Suggested front endplay of input shaft is .004"–.022". This endplay can be reduced by replacing the OE plastic washer with the Sonnax **34301-078** (.015" oversized) or **34301-094** (.030" oversized).



CAUTION: Do not shim a 400 forward drum from the pump support washer. Adding shim material here pushes the sealing rings into a very minimal surface contact on the drums.

2. THM 400 Rear Endplay Set-up

- Use a dial indicator on the output shaft to verify and obtain a rear unit endplay of .005"–.025".
- The Sonnax shim **34500-Z** is .010" (which installs between the sun gear and the rear internal gear) and can be used to reduce both front and rear unit endplay. The sun gear can only be shimmed to a certain point before it loads the center support. This amount depends on the rear unit accumulated wear. The shims between the rear case and output shaft hub also compensate for rear unit endplay. These OE shims range from .074"–.118".



NOTE: The **34500-Z** cannot be used in '97 and later 4L80-E center lube units.