

TOYOTA/LEXUS U151E, U151F, U250E ZIP KIT®

PART NUMBER U151E-U250E-ZIP

QUICK GUIDE

Parts are labeled here in order of installation. See other side of sheet for details on kit contents.

INSTALLATION DIAGRAM

Upper Valve Body

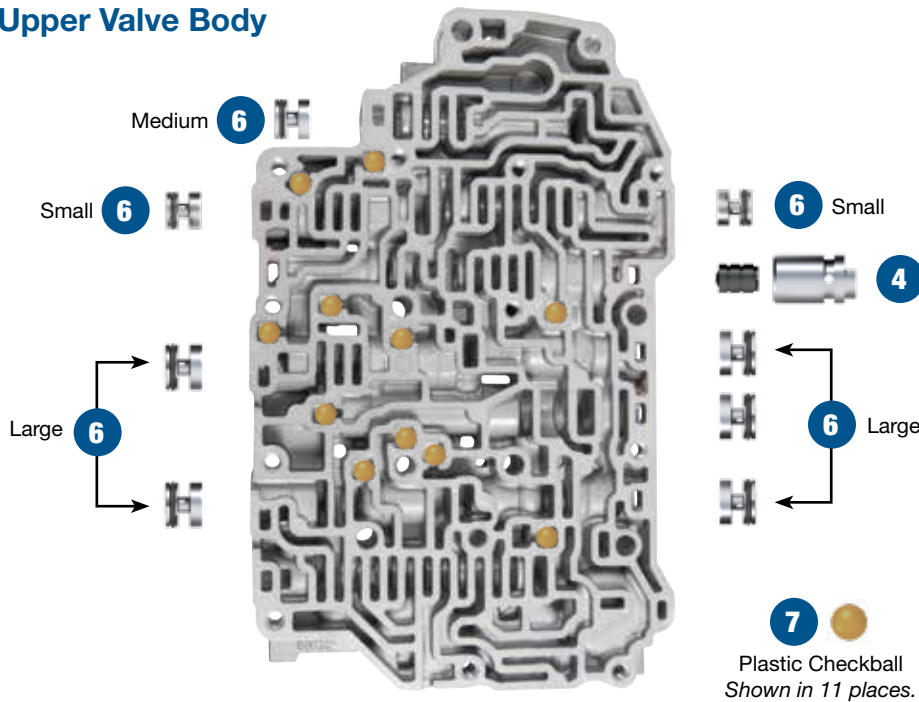

Install with open end out.

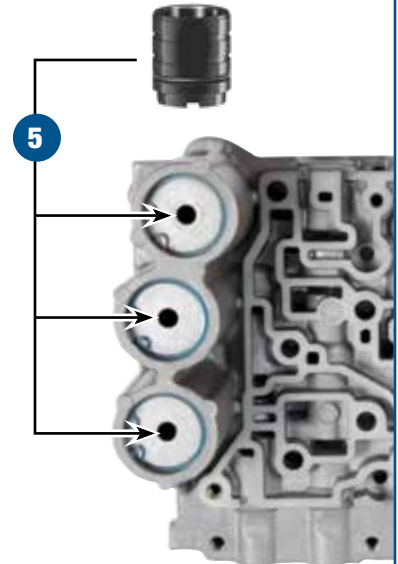

Lower Valve Body

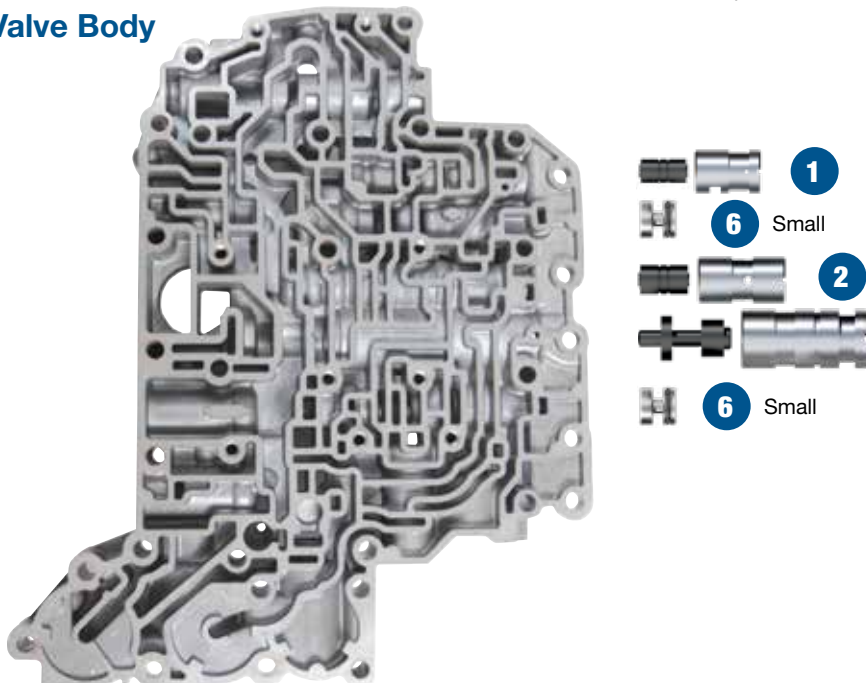

NOTE: Before removing OE boost sleeve, take note of the adjustable step/pin location and ensure the Sonnax sleeve is installed at the same height/location. Failure to do so will result in incorrect line pressure.

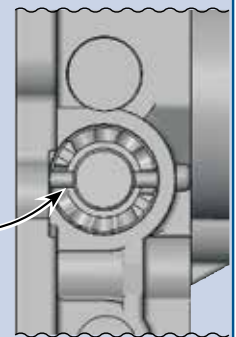

Cutaway shows a side view of lower valve body with Sonnax boost valve kit installed.

In addition to general rebuilding tips and technical information, the technical booklet included in this kit contains vacuum testing and additional repair options for higher mileage units or for repairing specific complaints which are beyond the scope of this kit.

Kit Contents & Installation Steps

Step 1 Replace OE B2 Plunger Valve & Sleeve

Packaging Pocket 1

- Plunger Valve
- Plunger Sleeve

Step 2 Replace OE B1 Plunger Valve & Sleeve

Packaging Pocket 2

- Plunger Valve
- Plunger Sleeve

Step 3 Replace OE Boost Valve, Sleeve & Plug



NOTE: Ensure Sonnax sleeve is installed at the same height/location as OE boost sleeve. Failure to do so will result in incorrect line pressure.

Packaging Pocket 3

- Boost Valve
- Boost Sleeve
- Boost Valve Plug

Step 4 Replace OE Lockup Control Plunger Valve & Sleeve

NOTE: Reuse OE spring if applicable.

Packaging Pocket 4

- Plunger Valve
- Plunger Sleeve

Step 5 Replace OE Accumulator Piston

NOTE: Use in the most worn location.

Place O-ring in deep groove, lubricate with Sonnax Slippery Stick™ O-LUBE and roll on bench to size.

Packaging Pocket 5

- Accumulator Piston
- O-Rings (2) 1 Extra

Step 6 Replace OE End Plugs

Place O-ring in groove, lubricate with Sonnax Slippery Stick™ O-LUBE and roll on bench to size. Install all end plugs with the O-ring outboard.

Packaging Pocket 6

- End Plugs, Large (5)
- O-Rings, Large (7) 2 Extra

Packaging Pocket 7

- End Plug, Medium
- O-Rings, Medium (2) 1 Extra

Packaging Pocket 8

- End Plugs, Small (4)
- O-Rings, Small (6) 2 Extra

Step 7 Replace OE Checkballs

Packaging Pocket 9

Plastic Checkballs (11)

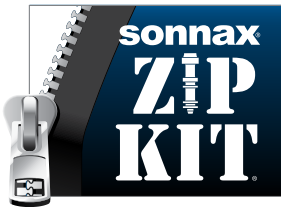

TOYOTA/LEXUS U151E, U151F, U250E ZIP KIT®

PART NUMBER **U151E-U250E-ZIP**

INSTALLATION & TESTING BOOKLET

Torque Specifications	
Pan Filter to Valve Body 8 ft-lb	Oil Pan to Transaxle 69 in-lb
Component Pack Clearance	
Forward (C1) Clutch U151E & U250E: .039-.049"	Low & Reverse (B2) Brake U151E: .046-.053" U250E: .029-.048"
2nd (B1) Brake U151E: .024-.036" U250E: .021-.036"	Reverse (C2) Input U151E & U250E: .024-.032"
Direct (C0) Clutch U151E: .024-.033" U250E: .020-.033"	Underdrive (B3) Brake U151E: .071-.087" U250E: .065-.087"
Underdrive (C3) Clutch U151E & U250E: .059-.067"	
End Play	
Input Shaft U151E & U250E: .010-.049"	Underdrive Unit U151E: .020-.040" U250E: .008-.027"
Direct Clutch Assembly U151E: .010-.036" U250E: .008-.038"	
Fluid	
Toyota Genuine ATF WS PN: JWS3324 or NWS9638 Fluid level should be between the 2 hot marks on the stick: • Dry Fill: 8.8 liters • Drain and Re-fill: 3.5 liters	

Electronic Cautions

Resetting Shift Adapts

The ECM (engine control module) has memorized values which must be relearned after transmission repair. Use a scan tool (OE factory tool recommended) to reset the ECM.

Post-Adapt Road Test

After resetting the ECM, a road test is required. Start the engine and warm it to normal operating temperature. Perform a thorough road test with multiple accelerations from a stop until proper shifting is obtained.

Solenoids

Solenoids should be cleaned to remove debris that results in sticking and malfunction.

Toyota/Lexus U151E/F, U250E Typical Solenoid Firing Order

Gear	SL1	SL2	SL3	S4	SR	DSL/TCC	SLT
1st	ON	ON	Off	Off	Off	ON/M1	Modulates based on engine load.
2nd	Off	ON	Off	Off	Off	Off	
3rd	ON	Off	Off	Off	ON	ON	
4th	Off	Off	ON	Off	ON	ON	
5th	Off	Off	ON	ON	ON	ON	

Toyota/Lexus U151E/F, U250E Component Application Chart

Gear Range	Forward Clutch C1	Reverse Input Clutch C2	Direct Clutch C0	Underdrive Clutch C3	2nd Brake B1	Low & Reverse Brake B2	Underdrive Brake B3	No. 1 One Way Clutch F1	No. 2 One Way Clutch F2
Park							ON		
Reverse		ON				ON	ON		
Neutral							ON		
D-1st Gear	ON						ON	ON	ON
D-2nd Gear	ON				ON		ON		ON
D-3rd Gear High Ratio	ON		ON	ON					
D-3rd Gear Low Ratio	ON		ON				ON		ON
D-4th Gear			ON		ON		ON		ON
D-5th Gear			ON	ON	ON				

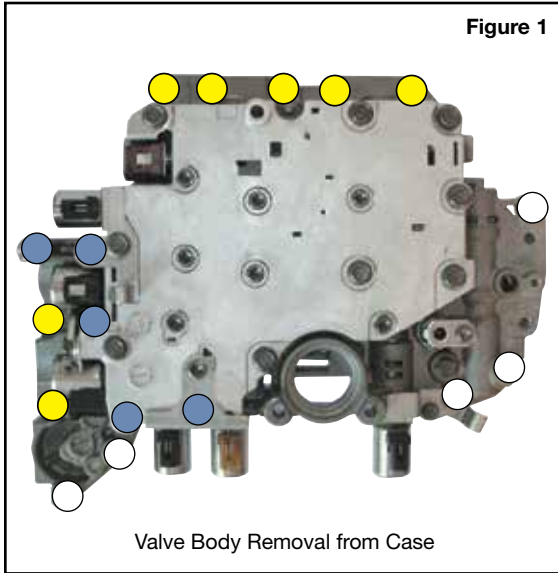

Zip Kit Instructions

1. Valve Body Removal from Case

Remove the 19 bolts indicated (Figure 1).

2. Valve Body Disassembly: Step 1

NOTE: See Figure 2 for bolt locations.

Solenoids can be put into the wrong location in the valve body. Ensure each of them are put back in their correct location. Solenoid designs have changed over the years, see Figure 3 for the most common configuration.

- a. Remove bolt #1 and locking plate. Remove shift solenoid SL3 and the SLT solenoid.
- b. Remove bolt #2 and shift solenoid S4, then SR solenoid.
- c. Remove bolt #3 and shift solenoid DSL.
- d. Remove bolt #4 and locking plate. Remove shift solenoid SL2.
- e. Remove bolt #5 and locking plate. Remove shift solenoid SL1.
- f. Remove the seven #6 bolts.
- g. Remove the #7 bolt.

Bolt Color Code	Bolt Length
Black	12mm
Red	16.75mm
Green	21.50mm
Yellow	25.00mm
Lt Purple	26.50mm
Olive	30mm
Purple	35.50mm
White	41.00mm
Lt Blue	46.50mm
Blue	57.00mm
Orange	62.50mm

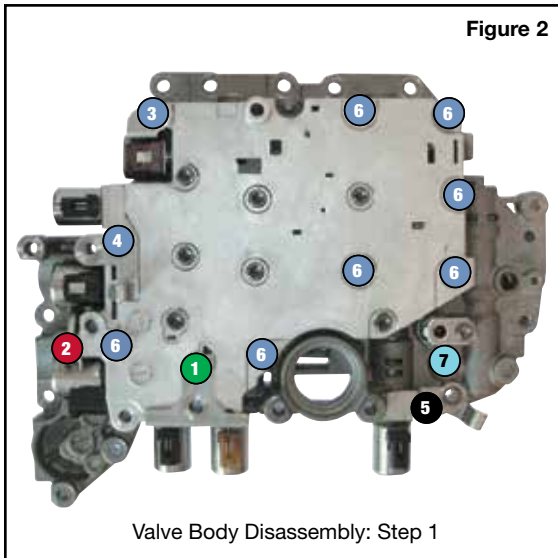

3. Valve Body Disassembly: Step 2

NOTE: See Figure 4 for bolt locations.

- a. Remove the light blue #1 bolt, retaining bracket and checkball.
- b. Remove the seven remaining light blue bolts.
- c. Remove the purple bolt.

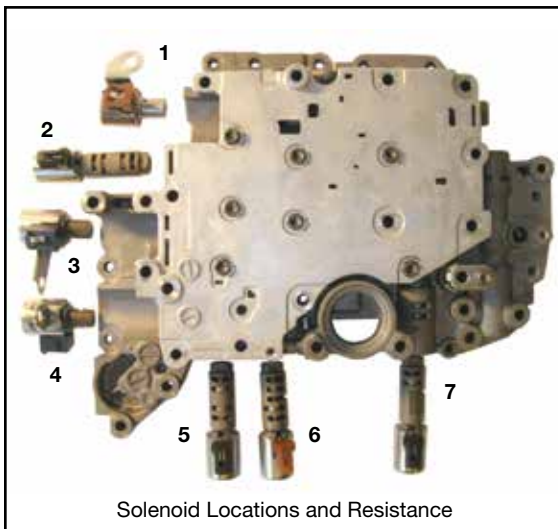

1. DSL (TCC) Solenoid, 11–15 Ohms
2. SL2 Solenoid, 4.5–6.0 Ohms
3. S4 Solenoid, 11–15 Ohms
4. SR Solenoid, 11–15 Ohms
5. SL3 Solenoid, 4.5–6.0 Ohms
6. SLT Solenoid, 4.5–6.0 Ohms
7. SL1 Solenoid, 4.5–6.0 Ohms

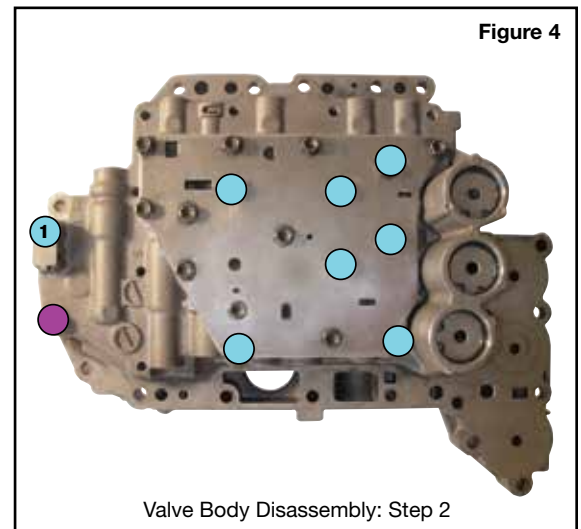

4. Installation

Install Zip Kit parts as shown on diagram of separate quick guide sheet included in this Zip Kit.

- When installing the lockup control plunger valve and sleeve kit in Step 4, reuse the OE spring between the new valve and sleeve.
- The Sonnax O-ringed end plugs in Step 6 must be installed with the O-ring outboard.

5. Valve Body Assembly: Step 1

NOTE: See **Figure 5** for bolt locations.

- Loosely install the **purple** bolt.
- Loosely install the seven, unnumbered **light blue** bolts.
- Loosely install the **light blue #8** bolt, retaining bracket and checkball.
- Torque all bolts to 90 in-lb.

6. Valve Body Assembly: Step 2

NOTE: See **Figure 6** for bolt locations and torque specifications.

- Loosely install bolt **#1**.
- Loosely install the seven **#2** bolts.
- Install shift solenoid SL1 and locking plate. Loosely install bolt **#3**.
- Install shift solenoid SL2 and locking plate. Loosely install bolt **#4**.
- Install shift solenoid DSL. Loosely install bolt **#5**.
- Install the SR solenoid, then shift solenoid S4. Loosely install bolt **#6**.
- Install shift solenoid SL3 and the SLT solenoid. Install the locking plate and loosely install bolt **#7**.
- Torque all bolts as indicated in chart (**Figure 6**).

7. Valve Body Reinstallation to Case

NOTE: See **Figure 7** for bolt locations.

- Loosely install all 19 bolts. Reference the color chart on previous page for bolt lengths.
- First tighten the two **#1** positioning bolts to 8 ft-lb. Torque the remaining bolts to the same 8 ft-lb.

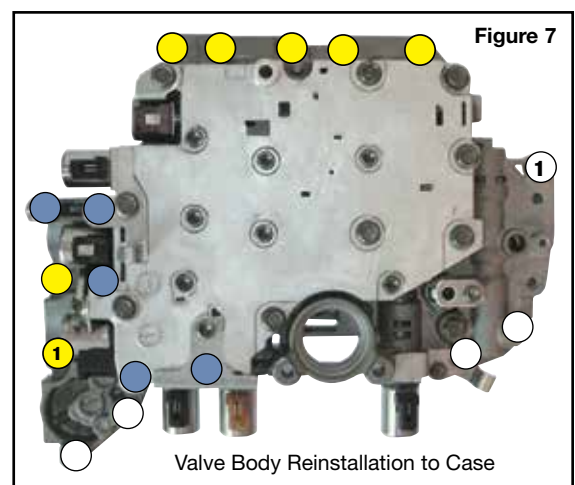
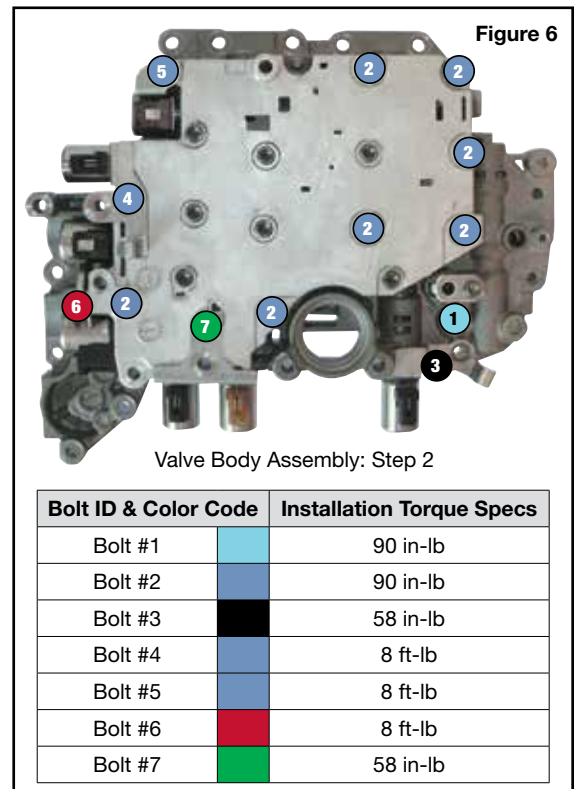
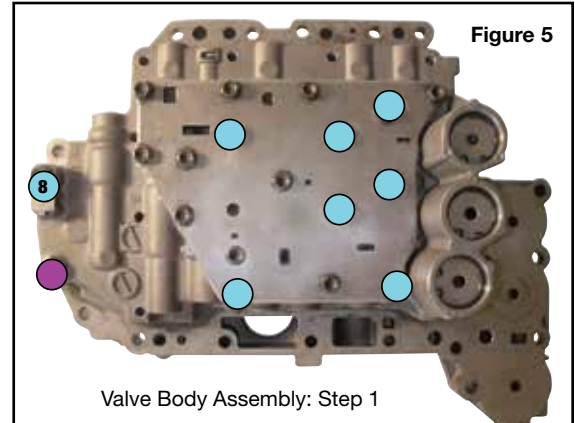

Critical Wear Areas & Vacuum Test Locations



Drop-In Zip Valve™
Parts Available

NOTE: OE valves are shown in rest position and should be tested in rest position unless otherwise indicated. Test locations are pointed to with an arrow. Springs are not shown for visual clarity. Low vacuum reading indicates wear and Sonnax parts are noted for replacement.

**Lower Valve Body – Bottom Side
U250E Shown Here**



For specific vacuum test information, refer to individual part instructions included in kits and available at www.sonnax.com.

**B2 (Low/Reverse) Apply ZIP
Control Plunger**

- Delayed Reverse
- B2 Brake clutches burned
- No engine braking in manual low
- Erratic shift timing

Replace with Sonnax Part No.
27741-06K*

**B1 (2nd) Apply ZIP
Control Plunger**

- 2-3 or 4-3 Bind-up
- B1 brake clutches burned
- Harsh 1 through 4 maneuver shifts
- Erratic shift timing

Replace with Sonnax Part No.
27741-04K*

NOTE: Seal port on opposite side when testing.

Boost Valve ZIP

- Soft shifts
- Low line rise in Drive
- High line pressure in Reverse

Replace with Sonnax Part No.
27741-01K*

Clutch Apply Control Valve

- Burnt Forward/C1 Clutch, Direct/C0 Clutch and 2nd/B1 Brake
- Flare shifts • Bind-ups

NOTE: Stroke valve to ensure it is not stuck.

4-5 Shift Valve

- Delayed 3rd
- UD/C3 Clutch burned
- Delayed/No 5th

B2 (Low/Reverse) Switch Valve

- B2 Brake clutches burned
- Delayed Reverse
- No engine braking in manual low

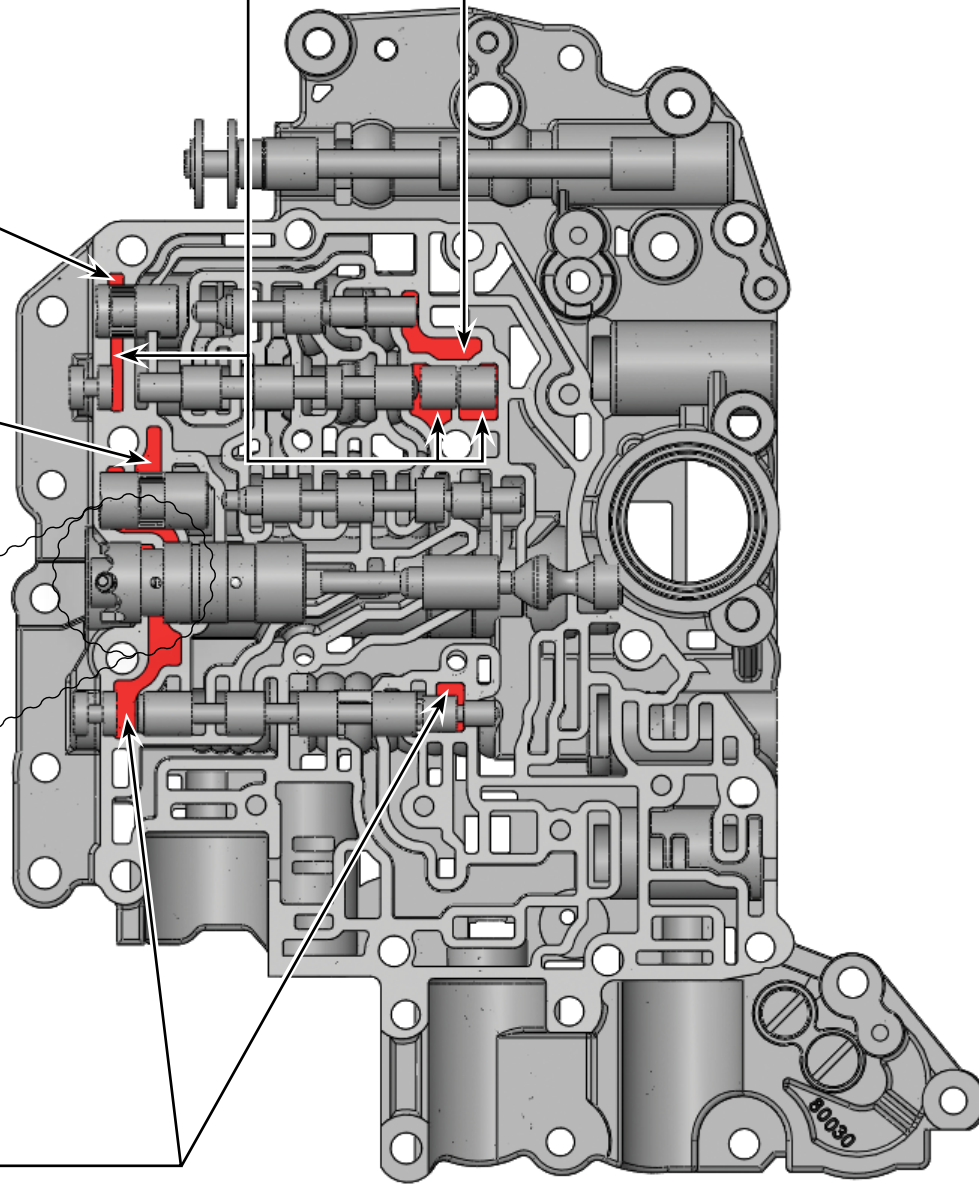

Part numbers with an asterisk () are included in this Zip Kit. Other part numbers are available separately.

Lower Valve Body – Top Side • U250E Shown Here

End Plugs, Multiple Locations 

- Inconsistent shift quality • Flare shifts
- Clutch failure • Bump shifts • Bang shifts
- Shift codes

Replace with Sonnax Part No.
27741-20K*

NOTE: Two Locations = ★

Pressure Regulator Valve

- Soft shifts • Low line pressure • Harsh shifts
- High line pressure in Reverse
- Clutch & band failures
- Low converter pressure • High line pressure

Replace with Sonnax Part No.
27741-08K Requires 57917E-TL8

Clutch Apply Control Valve

- Burnt Forward/C1 Clutch, Direct/C0 Clutch & 2nd/B1 Brake
- Flare shifts • Bind-ups

NOTE: Stroke valve to ensure it is not stuck.

B2 (Low/Reverse) Switch Valve

- B2 Brake clutches burned
- Delayed Reverse
- No engine braking in manual low

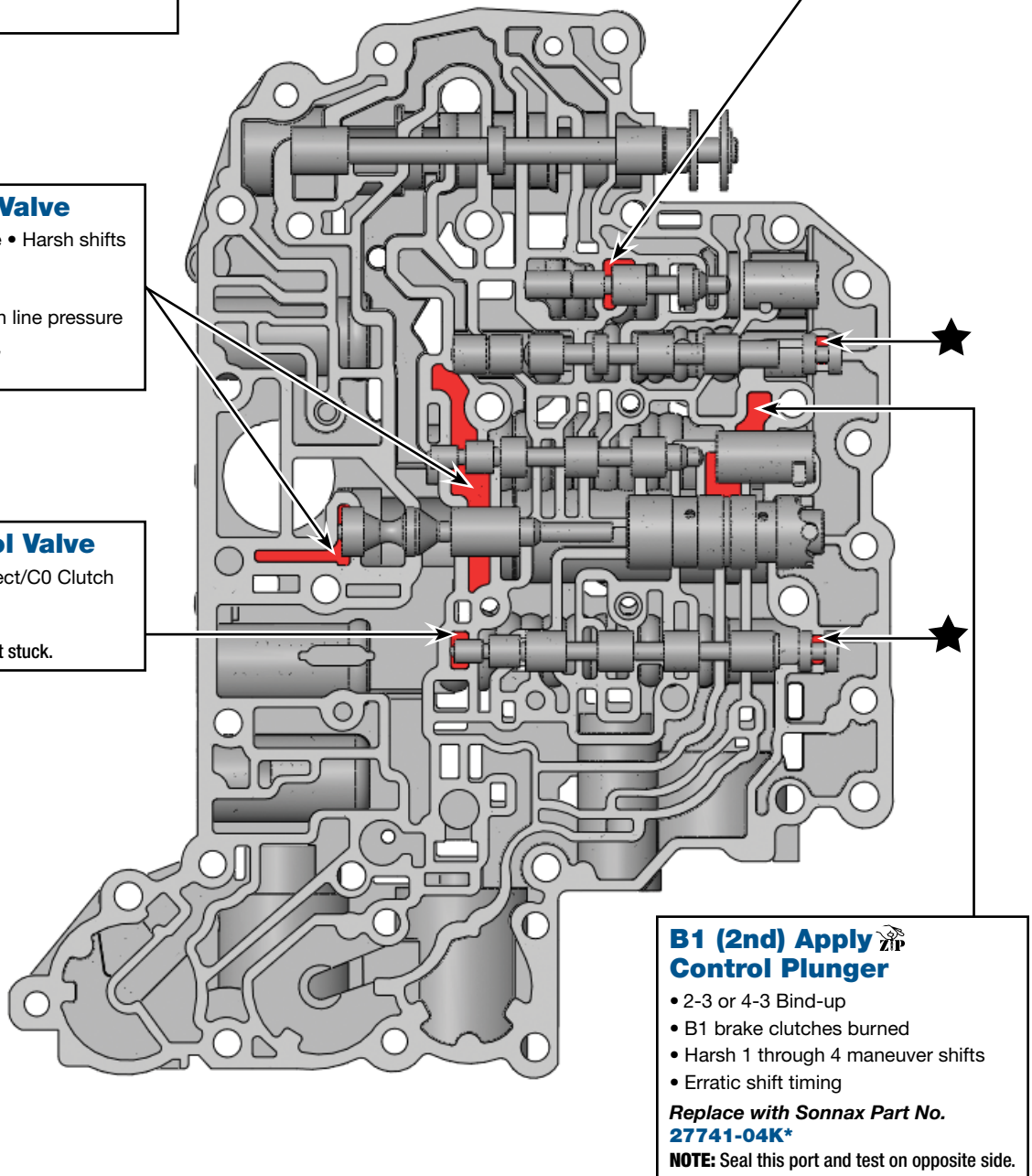

B1 (2nd) Apply 
Control Plunger

- 2-3 or 4-3 Bind-up
- B1 brake clutches burned
- Harsh 1 through 4 maneuver shifts
- Erratic shift timing

Replace with Sonnax Part No.
27741-04K*

NOTE: Seal this port and test on opposite side.

Items without part numbers are valid vacuum test locations for indicated drivability complaints, but do not have corresponding Sonnax parts due to low percentage of bore wear.

Critical Wear Areas & Vacuum Test Locations



Drop-In Zip Valve™
Parts Available

NOTE: OE valves are shown in rest position and should be tested in rest position unless otherwise indicated. Test locations are pointed to with an arrow. Springs are not shown for visual clarity. Low vacuum reading indicates wear and Sonnax parts are noted for replacement.

Upper Valve Body – Bottom Side • U250E Shown Here

End Plugs, Multiple Locations

- Shift concerns
- Clutch failure

Replace with Sonnax Part No.
27741-20K*

NOTE: Eight locations = ★

Solenoid Modulator Valve

- Slips & flares • Erratic shift feel & engagements
- Harsh upshifts • Bind-up • Low cooler flow
- Excess Reverse pressure & distorted housings
- TCC cycling/slip • Overheating

Replace with Sonnax Part No.
27741-13K Requires F-27741-TL13 & VB-FIX

B2 (Low/Reverse) Control Valve

- B2 Brake clutches burned
- Delayed Reverse
- Delayed engagement in manual 1st

B3 Orifice Control Valve

- Shift concerns
- UD/B3 Brake clutches burned

Accumulator Control Valve

- Shift concerns
- Burnt clutches & brakes

C0 (Direct) Control Valve

- C0 Clutch burned
- Slipping/Flares in 3rd, 4th & 5th

C0 (Direct) Accumulator Piston

- Delayed engagement • Flare shifts
- Forward slip • Burnt clutches

Replace with Sonnax Part No.
57917E-19K*†

B1 (2nd) Accumulator Piston

- Delayed engagement • Flare shifts
- Forward slip • Burnt clutches

Replace with Sonnax Part No.
57917E-19K*†

Solenoid Relay Valve

- Shift concerns

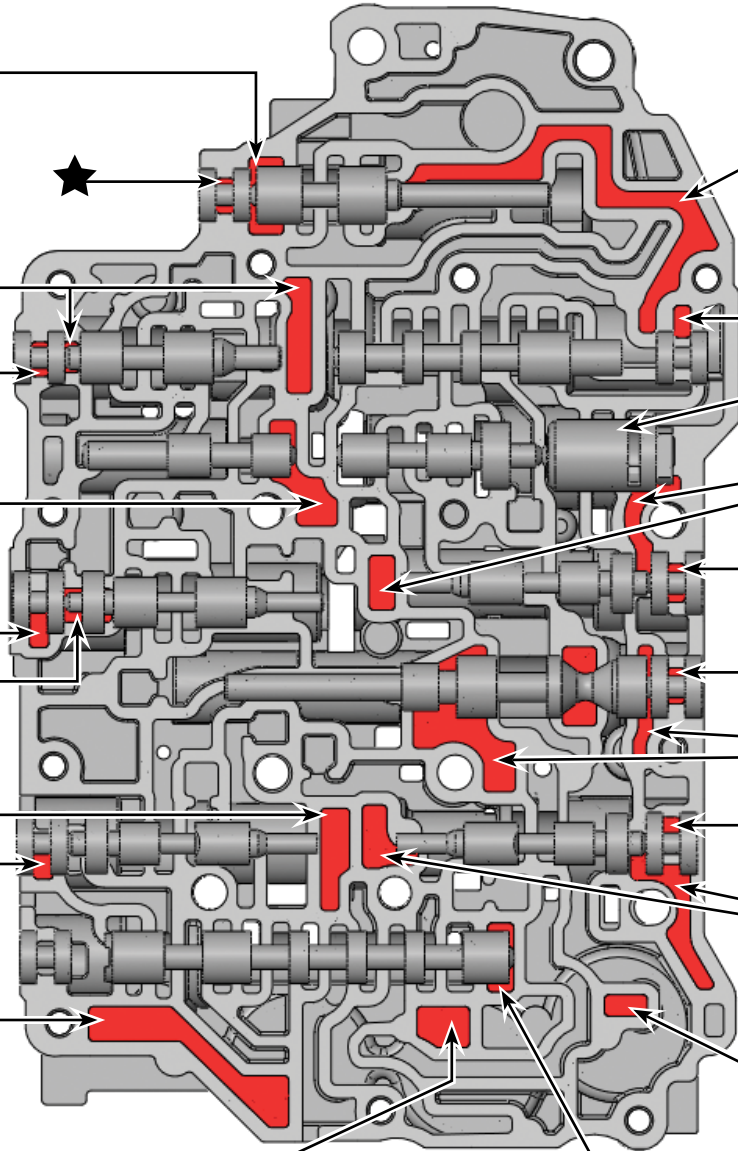

Part numbers with an asterisk () are included in this Zip Kit. Other part numbers are available separately.

†One accumulator piston kit included in Zip Kit, choose most worn location.



For specific vacuum test information, refer to individual part instructions included in kits and available at www.sonnax.com.

Upper Valve Body – Top Side • U250E Shown Here

Lockup Control Valve

- TCC apply & release concerns
- TCC codes
- Burnt converter

Replace with Sonnax Part No. 27741-25K REQUIRES F-27741-TL25 & VB-FIX

Lockup Relay Valve

- TCC apply & release concerns
- TCC codes
- Burnt converter/overheating

Lockup Control ZIP Plunger Assembly

- TCC apply & release concerns
- TCC codes
- Burnt converter

Replace with Sonnax Part No. 57917E-03K

NOTE: Vacuum testing of lockup control plunger assembly not possible while in casting. Perform visual inspection to identify wear.

B1 (2nd) Control Valve

- B1 Brake clutches burned
- Slipping/Flares in 2nd, 4th & 5th

Secondary Pressure Regulator Valve

- TCC apply & release concerns
- TCC codes
- Burnt converter
- Lube failures

Replace with Sonnax Part No. 57917E-16K REQUIRES F-57917E-TL16 & VB-FIX

C1 (Forward) Control Valve

- C1 Clutch burned
- Delayed engagement
- Slipping/Flares in 1st, 2nd & 3rd

NOTE: Seal these ports and test on opposite side.

C1 (Forward) ZIP Accumulator Piston

- Delayed engagement
- Flare shifts
- Forward slip
- Burnt clutches

Replace with Sonnax Part No. 57917E-19K*

C1 (Forward) Control Valve

- C1 Clutch burned
- Delayed engagement
- Slipping/Flares in 1st, 2nd & 3rd

NOTE: Seal ports on opposite side when testing.

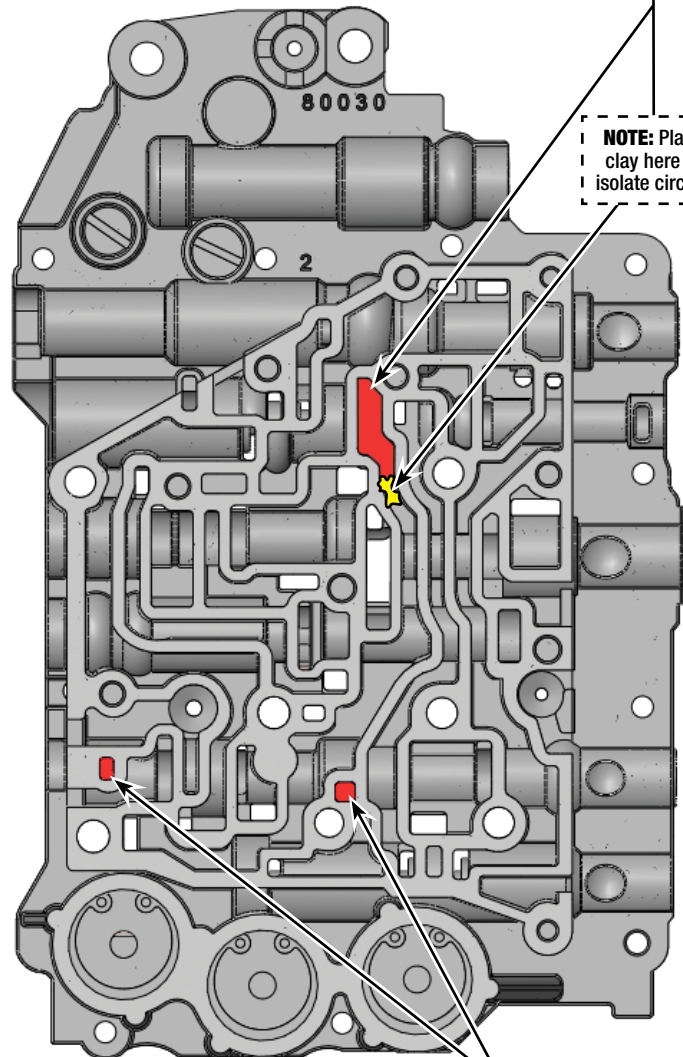

NOTE: Place clay here to isolate circuit.

Items without part numbers are valid vacuum test locations for indicated drivability complaints, but do not have corresponding Sonnax parts due to low percentage of bore wear.

OE Exploded View

Upper & Lower Valve Body • U250E Shown Here

Upper Valve Body Descriptions	
I.D No.	Description
201	Lockup Relay Valve
202	Lockup Control Valve & Plunger Valve Assembly
203	B1 Control Valve
204	Secondary Regulator Valve
205	C1 Control Valve
206	Solenoid Relay Valve
207	C0 Control Valve
208	Accumulator Control Valve
209	B3 Orifice Control Valve
210	B2 Control Valve
211	Solenoid Modulator Valve
212	C0 Accumulator Piston
213	B1 Accumulator Piston
214	C1 Accumulator Piston

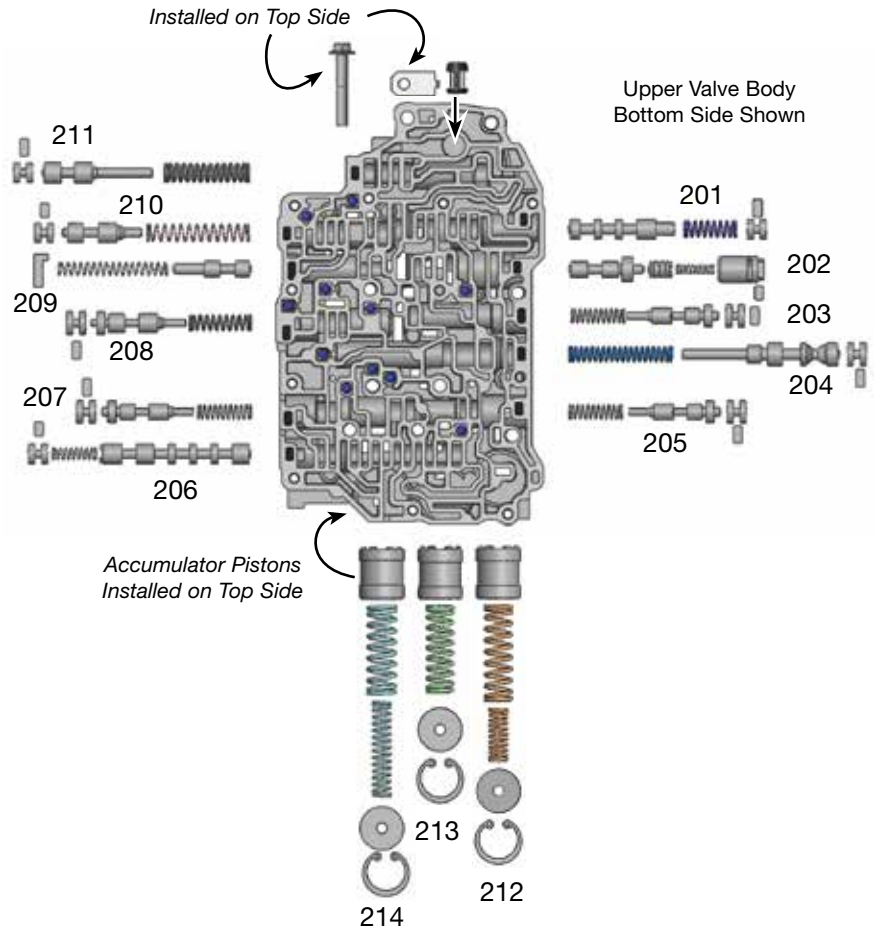

Lower Valve Body Descriptions	
I.D. No.	Description
101	Manual Valve
102	B2 Switch Valve & Plunger Valve
103	4-5 Shift Valve
104	B1 Switch Valve & Plunger Valve Assembly
105	Main Pressure Regulator Valve & Boost Valve Assembly
106	Clutch Apply Control Valve

