

ZF6HP19/26/32 (Gen. 1), Ford 6R60/75/80, ZF6HP21/28/34 (Gen. 2) ZIP KIT®

PART NUMBER ZF6-GEN2-ZIP

IDENTIFICATION GUIDE

Valve Body Identification

Valve components differ between Generation 1 (ZF6HP19/26/32), Ford 6R60, 6R75, 6R80 (2009-2014), 6R80 (2015-Later), 6R100 and Generation 2 (ZF6HP21/28/34) valve bodies. Please use this identification guide to determine which generation you have to ensure correct valve kits and components are selected for your rebuild.

Generation 1 (ZF6HP19, 26 & 32), Ford 6R60, 6R75, 6R80

Generation 2 (ZF6HP21, 28 & 34)

1st Generation Case Side
Includes 19, 26 & 32

1. IDENTIFY!

2nd Generation Case Side
Includes 21, 28 & 34

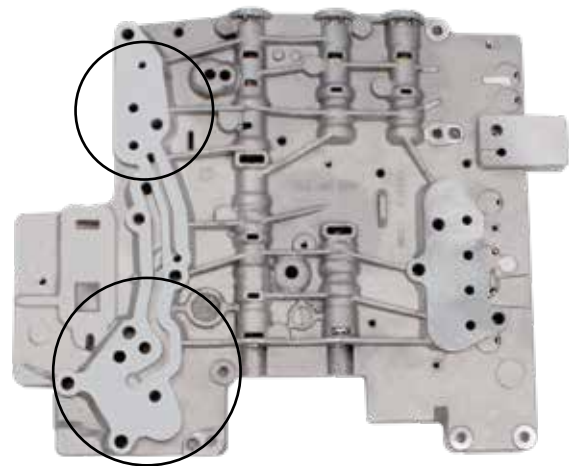
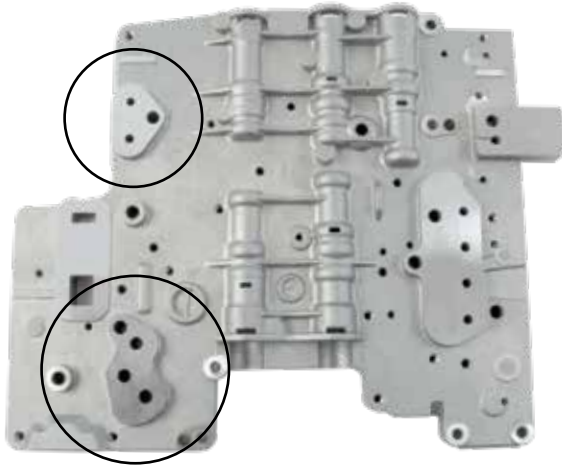

Different Sized Pressure Regulator
Valves and Sleeves

2. VERIFY!

Pressure Regulator Valves and Sleeves
Cannot Be Interchanged



Generation 1 (ZF6HP19, 26 & 32), with 053 Separator Plate



Verify OE dimensions
indicated in order to select correct
Sonnax parts.

NOTE: Some BMW 6 & 7 series with six accumulators have a different sized pressure regulator valve. This is most commonly seen on the A053/B053 separator plate applications.

CAUTION: Some valve sizes and locations differ from non-053 plate Generation 1 units. Reference 053 plate vacuum test guide and exploded view for details.



ZF6HP21/28/34 (Gen. 2) ZIP KIT®

PART NUMBER ZF6-GEN2-ZIP

QUICK GUIDE

Valve Body Identification

This Zip Kit **ZF6-GEN2-ZIP** is designed for ZF6HP21, ZF6HP28, ZF6HP34 (Generation 2) applications only. A separate Zip Kit **ZF6-6R60-ZIP** is available for ZF6HP19, ZF6HP26, ZF6HP32 (Generation 1) and Ford 6R60, 6R75, 6R80 (2009-2014), ZF6-053-ZIP is available for ZF6HP19, ZF6HP26, ZF6HP32 (Generation 1) units with an 053 separator plate, 6R80L-6R100-ZIP for 6R80 (2015-Later) and 6R100 applications. See separate identification guide for details.

INSTALLATION DIAGRAM

 Verify valve body is a Generation 2 model. See separate identification guide for details.

Upper Valve Body

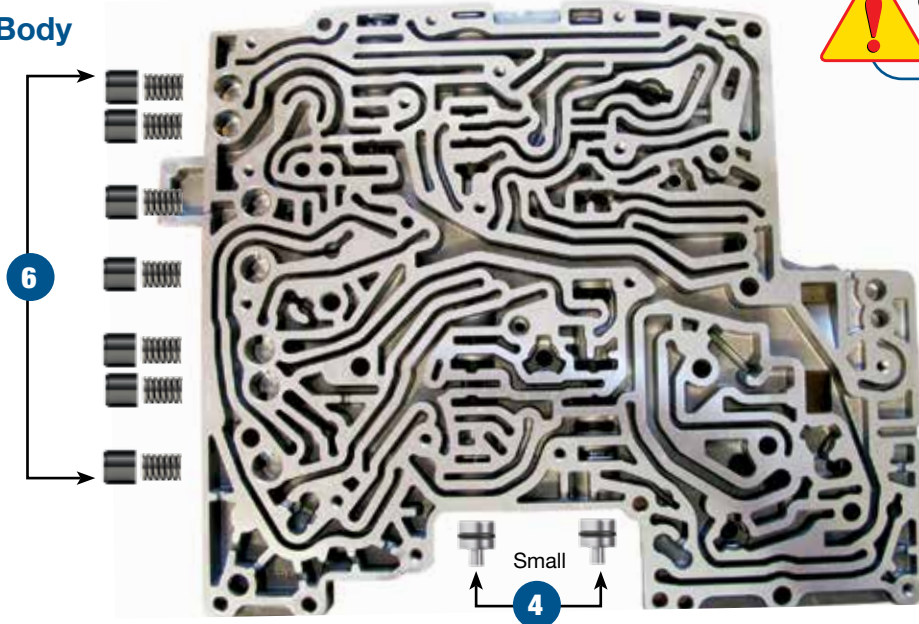

Lower Valve Body

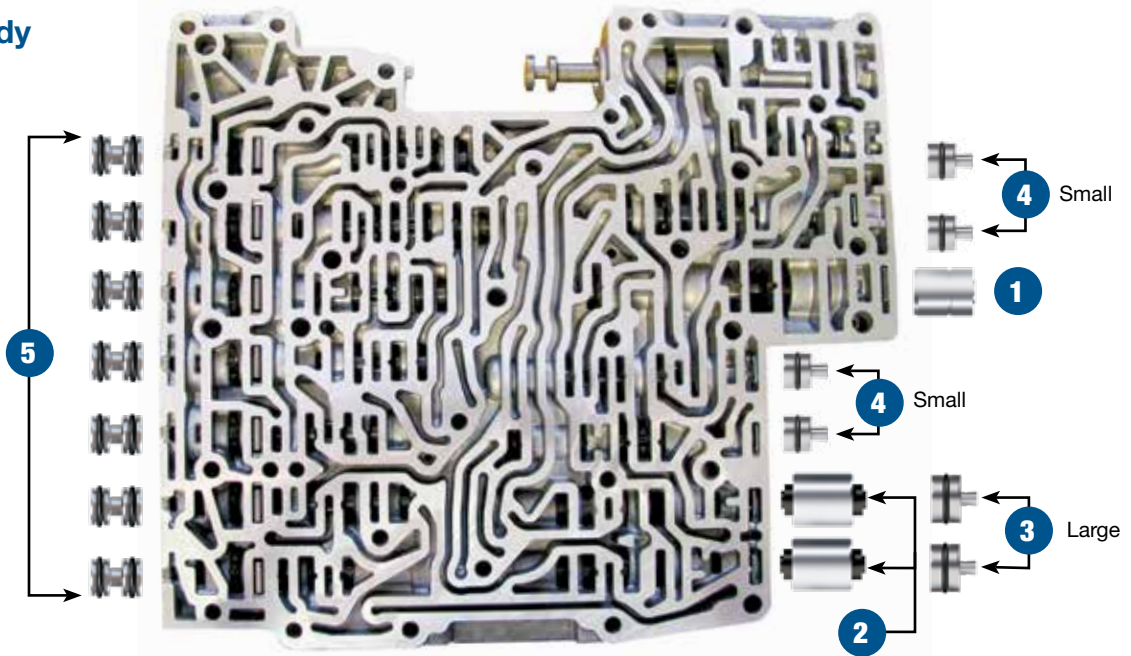

7
Solenoid O-Rings
Not Shown Here
See Page 3 of Booklet

In addition to general rebuilding tips and technical information, the technical booklet included in this kit contains vacuum testing and additional repair options for higher mileage units or for repairing specific complaints which are beyond the scope of this kit.

Kit Contents & Installation Steps

Step 1 Replace OE Sleeve



CAUTION: Verify pressure regulator valve and sleeve measurements! See separate Identification Guide for details.

Packaging Pocket 1

- Sleeve (.629" dia. x .804" length)

Step 2 Replace OE Sleeve & Valve

Packaging Pocket 2

- Valves (2)
- Sleeves (2)

Step 3 Replace Large OE End Plugs

Packaging Pocket 3

- End Plugs, Large (2)
- O-Rings, Large (4) 2 Extra

Step 4 Replace Small OE End Plugs

Packaging Pocket 4

- End Plugs, Small (6)
- O-Rings, Small (9) 3 Extra

Step 5 Replace Internal OE End Plugs



NOTE: Insert the internal end plug with the hole facing outboard.

Packaging Pocket 5

- End Plugs (7)
- O-Rings (20) 6 Extra

Step 6 Replace OE Pistons

Packaging Pocket 6

- Accumulator Pistons (7)
- Matching Springs (7)

Step 7 Replace OE Solenoid O-Rings

Packaging Pocket 7

- O-Rings, Size 10.5 x 2mm thick, Smaller (8)
- O-Rings, Size 13 x 2mm thick, Larger (7)

Packaging Pocket 8

- O-Rings, Size 13.5 x 2mm thick (4)

Packaging Pocket 9

- O-Rings, Size 14.5 x 1.5mm thick (5)

Packaging Pocket 10

- O-Rings, Size 14.5 x 2mm thick (3)

Packaging Pocket 11

- O-Ring, OR-014, Smaller (2)
- O-Ring, OR-016, Larger (2)



NOTE: See page 3 in the technical booklet included with this Zip Kit for details on replacement solenoid O-ring locations.

Step 8 Vacuum Testing

Packaging Pocket 12

- Testing Nut
- Testing End Plug



NOTE: See page 4 in the technical booklet included with this Zip Kit for instructions on how to vacuum test valve body castings with these two parts.

NOTE: Solenoids should be vacuum tested to ensure internal sealing integrity that cannot be determined with resistance check.

NOTE: Solenoid test manifold kit **95430-VTK** is available separately, and requires the **VACTEST-01K** vacuum test stand kit. Visit www.sonnax.com for more details.

NOTE: The parts listed here may be protected by patent number 8,794,108.



ZF6HP21/28/34 (Gen. 2) ZIP KIT®

PART NUMBER ZF6-GEN2-ZIP

INSTALLATION & TESTING BOOKLET

Valve Body Identification

This Zip Kit **ZF6-GEN2-ZIP** is designed for ZF6HP21, ZF6HP28, ZF6HP34 (Generation 2) applications only. A separate Zip Kit **ZF6-6R60-ZIP** is available for ZF6HP19, ZF6HP26, ZF6HP32 (Generation 1) and Ford 6R60, 6R75, 6R80 (2009-2014), ZF6-053-ZIP is available for ZF6HP19, ZF6HP26, ZF6HP32 (Generation 1) units with an 053 separator plate, 6R80L-6R100-ZIP for 6R80 (2015-Later) and 6R100 applications. See separate identification guide for details.

Torque Specifications

Mechatronic-to-Case or Valve Body Halves Bolts 8Nm/71 in-lb	Metal Oil Pan to Case 14Nm/10 ft-lb
Plastic Oil Pan to Case 10Nm/89 in-lb	Pump Bolts to Case 10Nm/89 in-lb
Output Shaft Flange Nut 60Nm/44 ft-lb	

Clearance & Endplay

Rear Unit Endplay (flanged output) 0.15-0.35mm/.006-.013"	Input Shaft Endplay 0.2-0.4mm/.008-.015"
--	--

Clutch clearance and material is critical (refer to OE clutch travel specifications). These have fluid balanced clutch pistons.

Fluid

Ford 6R60 extension housing has an allen head fill plug and/or the front corner of the case has a hex head fill plug. A dipstick lives within this plug.

Note: *The thermal element must open (88°C, 190°F) to purge the cooler before verifying the fluid level!*

Complete Fill Required 9.5 qt./9 ltr.	Service Fill Approx. 4.2 qt./4 ltr.
Ford Fluid XT-6-QSP, Mercon SP	ZF Fluid S671 090 0255- Shell M-1375.4

Drive-Cycle Relearn

Ford requires six light throttle up and coastdown shift cycles (after obtaining 80°C/175°F) for a partial relearn.

Cautions

Electronics

Do not use an ohm meter with more than .6 voltage supply. The TCM is capable of limited solenoid adaptation without reprogramming. After any service, resetting adapts/clearing KAM is suggested. In many instances, solenoids can be replaced with new OE or with qualified used. Original solenoids, if reused, should be returned to their same location due to a learned flow rate by the TCM. Make every effort to avoid mixing up the solenoids.

It is not advised to attempt circuit testing through the 16-pin connector. Check the solenoid resistance (5.0 ohms at 20°C/68°F) with the circuit board removed.

Visual Identification

The ZF6 has two generations:

- 2002–2005 ZF6HP19, ZF6HP26, ZF6HP32 = Generation 1
- 2006-later ZF6HP21, ZF6HP28, ZF6HP34 = Generation 2

The 19, 26 and 32 of Generation 1 ZF6 units refer to the sequentially larger amounts of torque capacity. In 2006, the mechatronic was upgraded to increase oil flow, which reduced the duration of the shift. These units became known as Generation 2, and were given the numbers 21, 28 and 34. The photos on the separate identification guide show how to identify and verify the valve body as a Generation 1 or Generation 2 version with the updated solenoids.

Within both vintages, there is an “M” version for the manual valve and an “E” solenoid controlled manual valve. The “E” version in both the early and late generations will have two additional solenoids, for a total of 9.

Technical Tips

Reprogramming

As indicated on the photo (**Figure 1**) an engraved number identifies this mechatronic as a service unit. This exchange unit may also have a blue paint dot, (**Figure 2**) on the solenoid end of the plastic frame, next to the bar code part number. This blue dot indicates it is NOT programmed and that the unit must be flashed with vehicle application prior to installation.

A white dot in the same area indicates the unit HAS been programmed without the transmission.

A pin dot identification in the same area with a fifth, sixth or seventh digit of 128 indicates this is a NEW unit, not a serviced mechatronic.

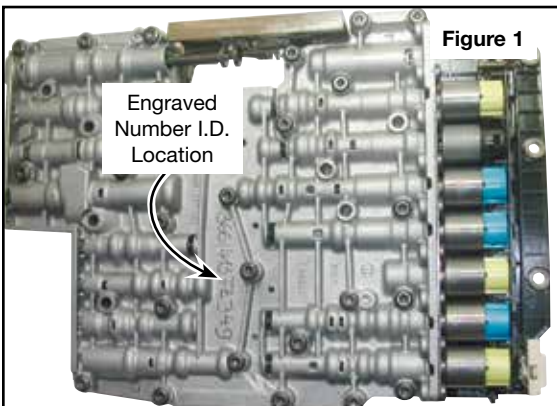

OE Serviced Valve Body

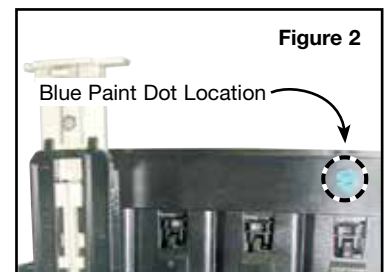
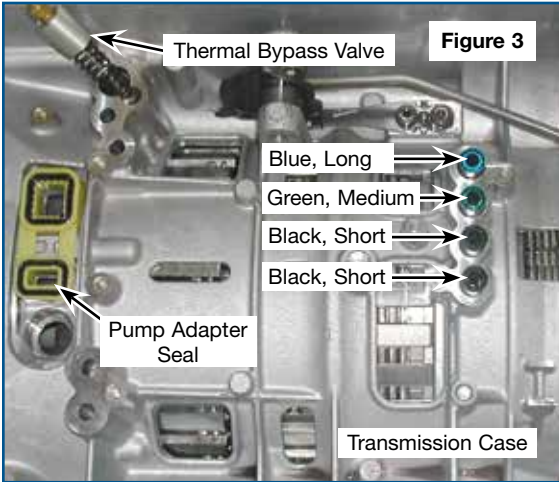

Figure 2



Technical Tips (continued)

Transmission Specifications & Reassembly Tips

ZF suggests the body-to-case, pump in/out adapter seal be replaced on every valve body R-R (Figure 3). The overall seal height on these vary depending on application. Make sure you have the correct size.

There are four mechatronic-to-case center support seals. The longest (blue) resides next to the manual linkage, medium (green) next to it. The two shortest ones (black) are furthest from the linkage (Figure 3).

Zip Kit Instructions

1. Valve Body Removal from Case

- a. Press release tab and lift connector retainer (Figure 4).
- b. Pull connector sleeve out of case.
- c. Remove 10 or 11 bolts to drop valve body from case (Figure 5).

2. Valve Body Disassembly

- a. Remove seven bolts to remove TCM from valve body (Figure 6).
- b. Remove TCM (Figure 7).
- c. Pry valve body halves from separator plate where indicated (Figure 8).

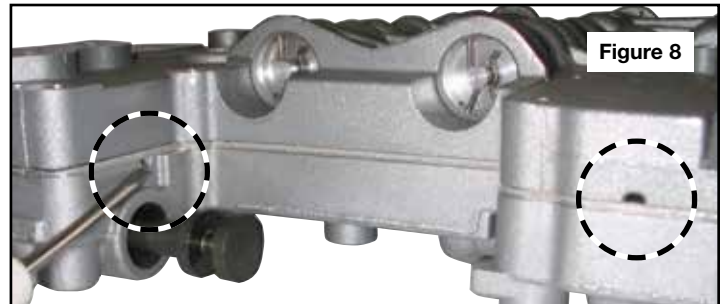
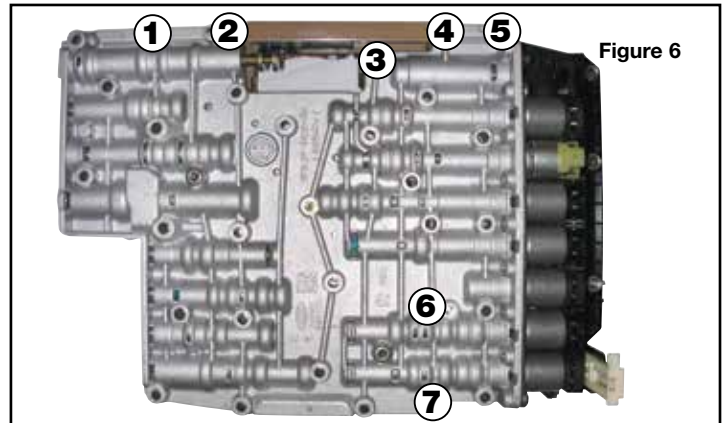
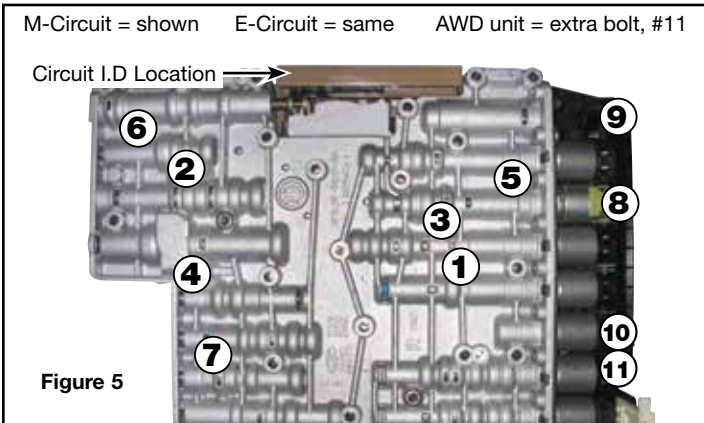
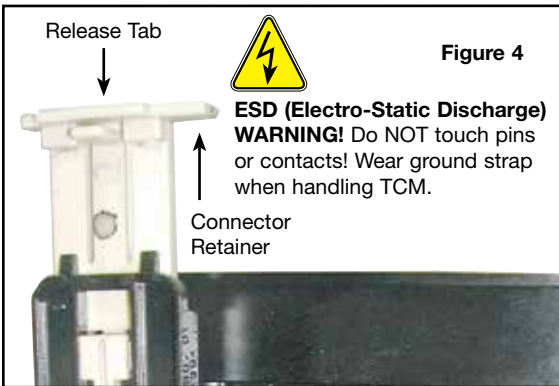

2. Valve Body Disassembly (continued)

NOTES: The separator plate has a bonded gasket which may delaminate during disassembly (Figure 9). If any damage or delamination to the gasket is present, a new Sonnax separator plate should be used.

These separator plates are specifically calibrated, requiring either the OE valve body code or an identification number stamped on original plate (Figures 10 & 11) for reorder. See Sonnax application chart for cross-reference numbers (Figure 12).

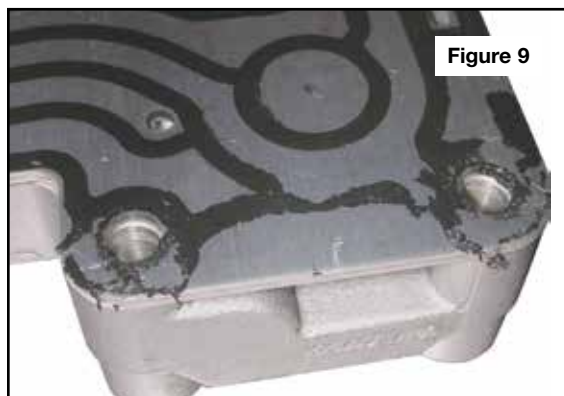

Figure 9

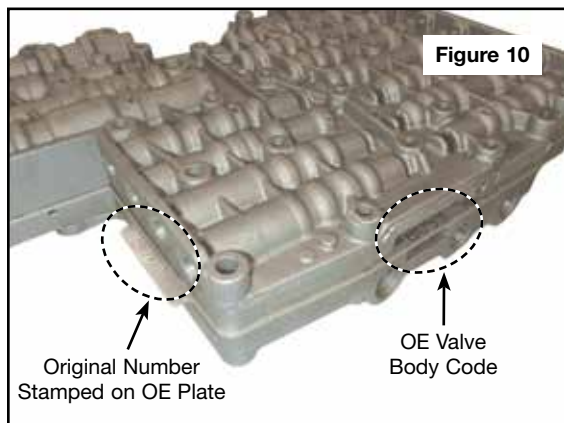

Figure 10

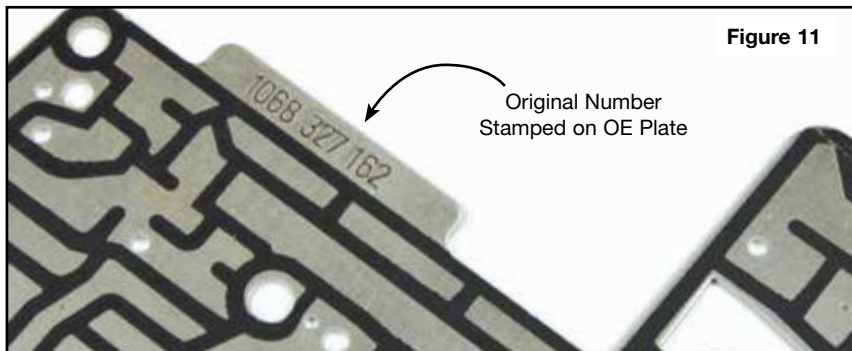

Figure 11

Valve Body Separator Plate Application Chart Figure 12

OE Valve Body Code	Number Stamped on Original Plate	Order Sonnax Part Number	Valve Body Generation
E510F	6L2P-7Z490-FC or 6L2P-7Z490-FB	95740-510**	Ford 6R60
A035/B035	1068-327-141	95740-035	ZF6HP19/26/32 (Generation 1)
A036/B036	1068-327-145	95740-051*	
A046/B046	1068-327-162	95740-046	
A047/B047	1068-327-163	95740-047	
A051/B051	1068-327-179	95740-051*	
A052/B052	1068-327-180	95740-052	
A053/B053	1068-327-189	95740-053	ZF6HP21/28/34 (Generation 2)
A063/B063	1068-327-210	95740-063	
A065/B065	1068-327-224	95740-065	

*Sonnax valve body plate **95740-051** is a direct replacement for both OE valve body codes A036/B036 and A051/B051, due to supersession by ZF.

Sonnax valve body plate **95740-510 is a replacement for OE plates stamped with part number 6L2P-7Z490-FB or 6L2P-7Z490-FC.

3. Installation

Install Zip Kit parts as shown on diagram of separate quick guide sheet included in this Zip Kit. The locations of the replacement solenoid O-rings are shown at left (Figure 13). For additional solenoid information see Solenoid O-Ring Sizes chart (Figure 14) and Solenoid Function chart (Figure 15) on page 8 of this booklet.

Sonnax recommends vacuum testing critical wear areas not covered by this kit to determine whether additional Sonnax parts are required (see pages 4–5).

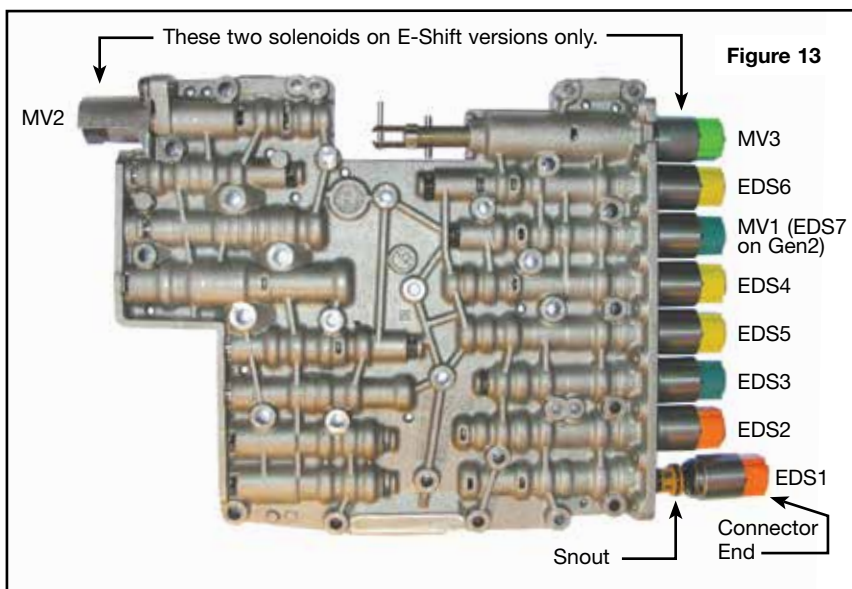

Figure 13

NOTE: O-ring sizes vary depending upon solenoid, location, make, model and generation version. Included in this Zip Kit are 31 standard replacement-size O-rings for the various solenoids. It is recommended to verify the size of the replacement O-ring by physically comparing it against the OE. The chart (Figure 14, page 8) provides some general guidance.

Critical Wear Areas & Vacuum Test Locations



NOTE: OE valves are shown in rest position and should be tested in rest position unless otherwise indicated. Test locations are pointed to with an arrow. Springs are not shown for visual clarity. Low vacuum reading indicates wear and Sonnax parts are noted for replacement.

Lower Valve Body • ZF6HP21, Generation 2, M-Shift Shown



For specific vacuum test information, refer to individual part instructions included in kits and available at www.sonnax.com.

Clutch B Control Pressure Regulator Valve

- Burnt B Clutch
- 3rd or 5th Shift concerns

Clutch A Latch Valve

- Burnt A Clutch
- 4-5 Shift concerns

Vacuum test these plugs at the retainer slot. This checks both diameters of the plug.

End Plugs
Inconsistent shift quality
Replace with Sonnax Part No. 95740-30K*

NOTE: Insert internal end plugs with hole facing outboard.

Clutch C Control Pressure Regulator Valve

- Burnt B Clutch
- 2nd or 6th Shift concerns

Clutch A Control Pressure Regulator Valve

- 5-4 Flare/Neutral
- No 4-5
- VFS 1/A solenoid control code
- Delayed/Harsh Forward

Replace with Sonnax Part Nos. 95740-28K* Boost Valve Kit or 95740-72K Oversized Valve Kit, E-Shift Only
Requires F-95740-TL72 & VB-FIX

Test 2: Test these ports after inserting test nut between control valve & plunger.

Clutch E Control Pressure Regulator Valve

- Coastdown Neutral
- Flare shifts & bind-ups
- Harsh downshifts
- Pressure control out-of-range codes

Replace with Sonnax Part Nos. 95740-28K* Boost Valve Kit or 95740-72K Oversized Valve Kit, E-Shift Only
Requires F-95740-TL72 & VB-FIX

Clutch Cooling Valve

- Burnt A clutch
- Burnt D brake

Bypass Clutch Control Regulator Valve

- TCC codes • Low converter pressure
- Excess TCC slip RPM & related codes
- Overheated converter • Flare/Harsh shifts
- Rough idle in Reverse

Main Pressure Regulator Valve

- Erratic line pressure • High line pressure
- Broken parts due to excessive line pressure
- Restricted converter/lube flow

Replace with Sonnax Part Nos. 95740-29K* Pressure Regulator Sleeve or 95740-69K Oversized PR Valve Kit Requires F-95740-TL69 & VB-FIX

Test 2: Test this port after inserting test nut into bottom of sleeve.

Test 1: In Rest

Test 1: In Rest

Converter release regulator valve and spring shown in inverted position. Use test end plug.

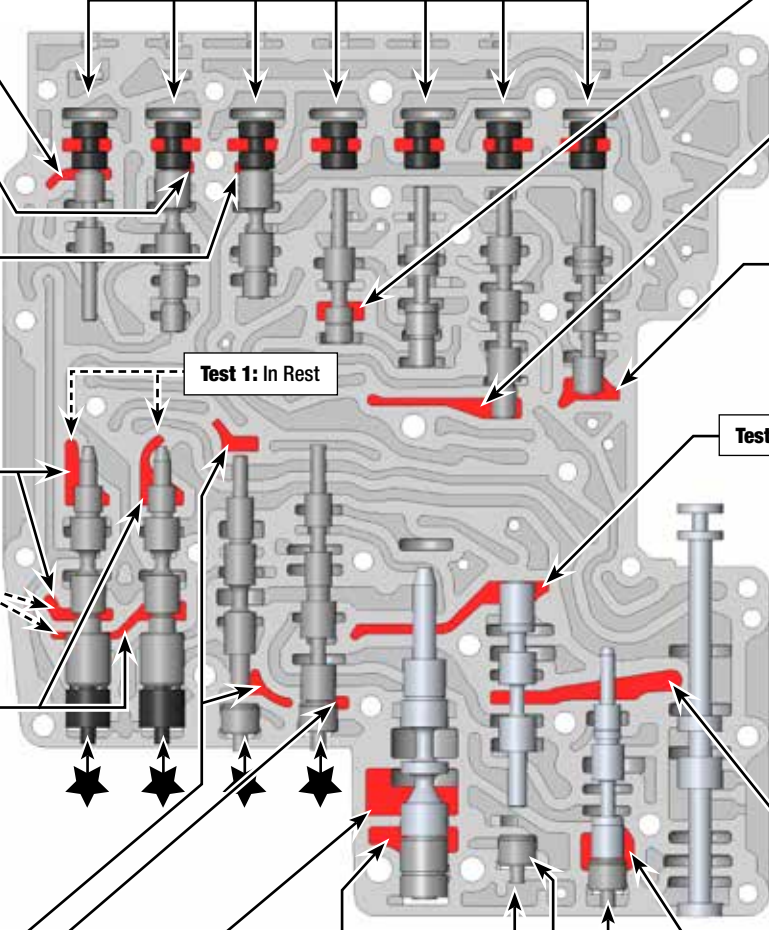

Part numbers with an asterisk () are included in this Zip Kit. Other part numbers are available separately.

Upper Valve Body • ZF6HP21, Generation 2, M-Shift Shown

There are numerous OE circuit/worm-track configurations. They are make, model, generation and E- vs M-Shift dependent. Use the illustrated port locations as a guide for identifying specific valve spools to vacuum test on alternate circuit configurations.

Clutch D2 Brake Latch Valve

- 1st or 2nd Shift concerns
- EDS 6 codes
- Burnt D brake

Test part after inserting test nut into bottom of bore.

Shift Valve 1

No fail safe

Clutch D1 Brake Latch Valve

- 1st or 2nd Shift concerns
- EDS 6 codes
- Burnt D brake

Converter Release Regulator Valve

- Excessive TCC slip RPM & related codes
- Flare shifts
- Harsh TCC apply & release
- Low TCC release pressure
- Rough idle in Reverse
- Harsh downshifts
- Overheated converter

Replace with **Sonnax Part No. 95740-05K**
Requires F-95740-TL5 & VB-FIX

Test 2: Test this port with valve in inverted position. Hold valve and spring in place with enclosed testing end plug.

Lubrication Control Valve

- Bearing/Bushing/Planetary/Lube failures
- Low converter pressure
- Overheating
- TCC codes & concerns
- Rough idle in Reverse

Replace with **Sonnax Part No. 95740-71K** Requires F-95740-TL71 & VB-FIX

End Plugs

Inconsistent shift quality

Replace with **Sonnax Part No. 95740-27K*** NOTE: Several Locations = ★

OE accumulator pistons should be flush with or approximately .030" lower than the casting surface. It is common for the rubber insert to lose tension.

Each of these pistons can be vacuum tested from the exhaust hole on the opposite side of the casting.

Accumulator Pistons

- Downshift clunk
- Firm shifts
- Erratic EDS solenoid control and/or EDS codes

Replace with **Sonnax Part No. 95740-15K***

Clutch D1 Brake Regulator Valve

- 1st or 2nd Shift concerns
- EDS 6 codes
- Burnt D brake

Shift Valve 3 M-Shift Only

- Harsh Reverse
- Reverse slip
- D1 Brake burned

Position Valve E-Shift Only

- Shift concerns
- A Clutch burned
- B Clutch burned
- E Clutch burned

Replace with **Sonnax Part No. 95740-75K** Oversized Kit, E-Shift Only
Requires F-95740-TL75 & VB-FIX

Solenoid Pressure Regulator Valve

- Delayed engagement
- Flare/Neutral shifts
- Harsh downshifts
- High line pressure
- Harsh upshifts
- Wrong gear starts
- Gear ratio & solenoid codes
- TCC slip

Replace with **Sonnax Part No. 95740-64K** Requires F-95740-TL17 & VB-FIX

Shift Valve 2

- Burnt A & E clutches
- Shift concerns

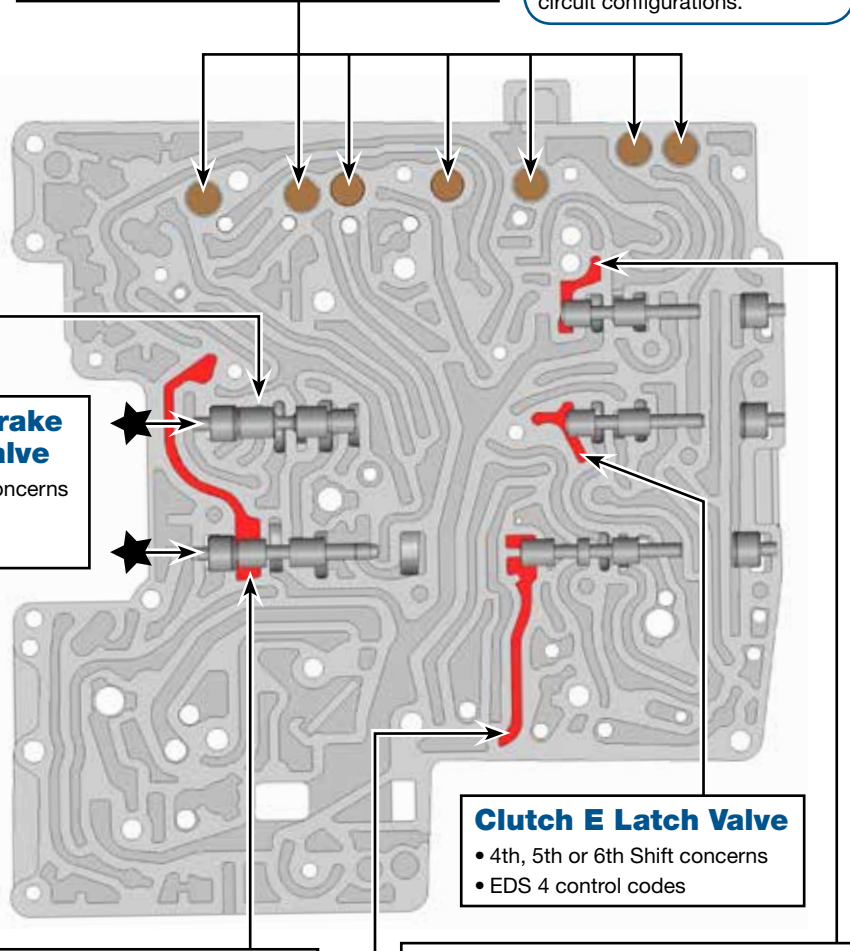

Part numbers with an asterisk () are included in this Zip Kit. Other part numbers are available separately.

OE Exploded View

Lower Valve Body • ZF6HP21, Generation 2, M-Shift Shown Here

NOTE: Depending upon vehicle application, the OE springs, checkballs and worm tracks may vary.

Lower Valve Body Descriptions	
I.D. No.	Description
101	Parking Lock Valve in E-Shift
101	Manual Valve in M-Shift
102	Lubrication Control Valve
103	Converter Release Regulator Valve
104	Main Pressure Regulator Valve
105	Bypass Clutch Control Regulator Valve
106	Clutch Cooling Valve
107	Clutch E Control Pressure Regulator Valve (inboard) Boost Valve & Sleeve (outboard)
108	Clutch A Control Pressure Regulator Valve (inboard) Boost Valve & Sleeve (outboard)
109	Park Lock Cylinder in E-Shift
109	Empty in M-Shift
110	Clutch D1 Brake Latch Valve
111	Shift Valve 1
112	Clutch D2 Brake Pressure Regulator Valve
113	Clutch D2 Brake Latch Valve
114	Clutch C Control Pressure Regulator Valve
115	Clutch B Control Pressure Regulator Valve
116	Clutch A Latch Valve

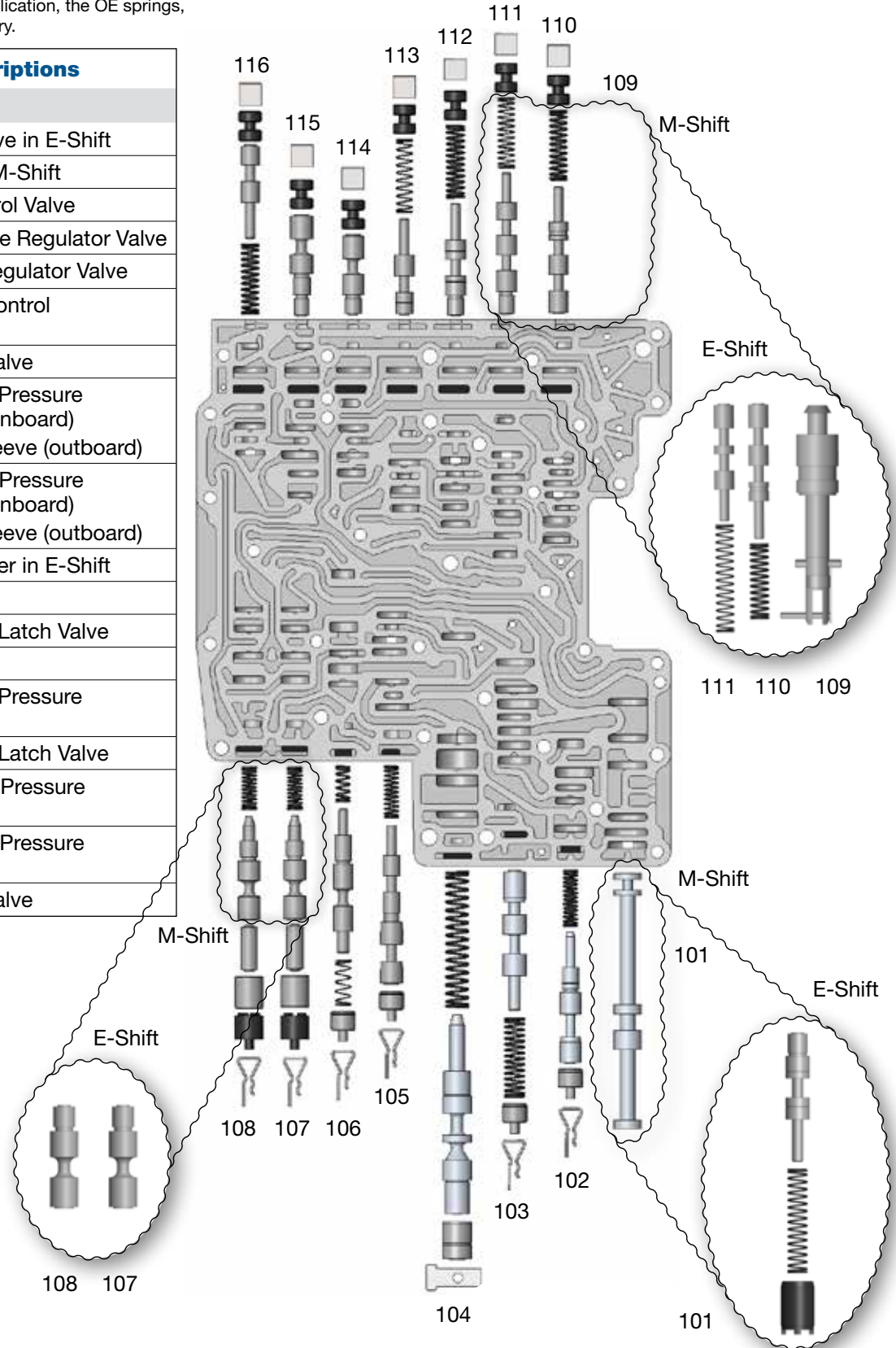

Upper Valve Body • ZF6HP21, Generation 2, M-Shift Shown Here

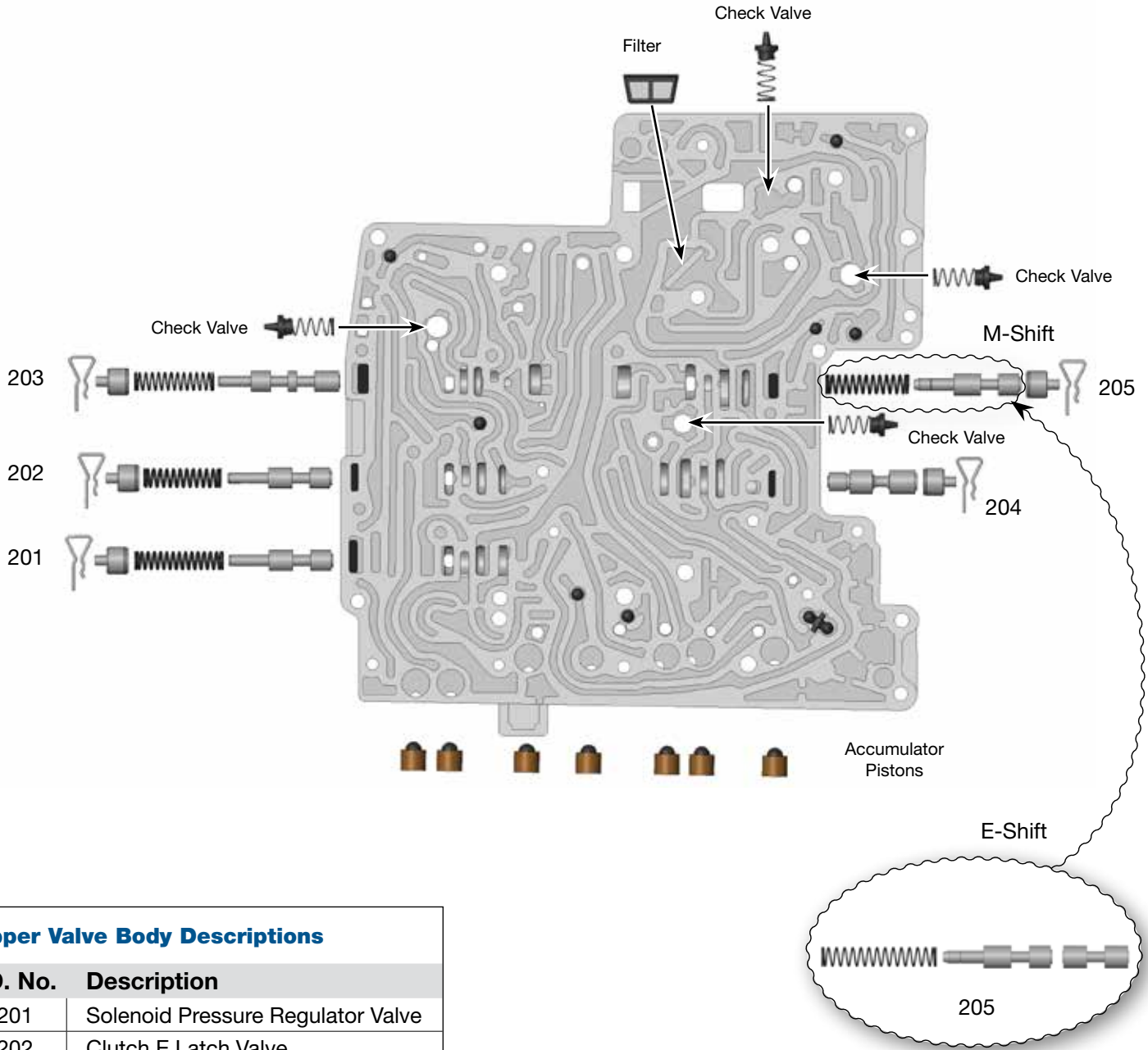

Upper Valve Body Descriptions

I.D. No.	Description
201	Solenoid Pressure Regulator Valve
202	Clutch E Latch Valve
203	Shift Valve 2
204	Clutch D1 Brake Regulator Valve
205	Shift Valve 3 in M-Shift
205	Position Valve in E-Shift

Technical Tips (continued from page 3)

ZF Solenoid O-Ring Sizes Figure 14			
Connector Color	Snout Color	Inboard O-Ring Size	Outboard O-Ring Size
Yellow / Green**	Black	10.5 x 2mm	13.5 x 2mm
Blue / Black / Gray**	Yellow	10.5 x 2mm	13 x 2mm
Orange	Orange	10.5 x 2mm	14.5 x 2mm
Black (Typical MV1 solenoid in Gen 1 & MV2 solenoid on E-Shifts)	Short Black	14.5 x 1.5mm	14.5 x 1.5mm



CAUTION: Solenoid connector colors can fade with high mileage and high temperature. Example: blue can look like green and yellow can look like tan.

ZF Solenoid Function Figure 15				
Connector Color	Location	Output	Resistance at 68°F (20°C)	Function
Generation 1: ZF6HP19, ZF6HP26, ZF6HP32				
Yellow / Green**	EDS 1, 3, 6	0 psi (0 bar) at 0 mA	5.05 ohms	1 – A Clutch; 3 – C Brake; 6 – TCC
Blue / Black / Gray**	EDS 2, 4, 5	67 psi (4.6 bar) at 0 mA	5.05 ohms	2 – B Clutch; 4 – D & E Clutch; 5 – EPC
Black	MV1	Open/Closed	11.5 ohms	Selector Valve
Black	MV2	Open/Closed	11.5 ohms	Park Lock Valve
Green	MV3	Open/Closed	24-26 ohms	Park Lock Cylinder
Generation 2: ZF6HP21, ZF6HP28, ZF6HP34				
Orange	EDS 1, 2	0 psi @ 0mA	5.05 ohms	1 – A Clutch; 2 – TCC
Yellow	EDS 4, 5, 6	0 psi @ 0 mA	5.05 ohms	4 – E Clutch; 5 – C Clutch; 6 – D1 & D2 Brake
Blue	EDS 3, 7	67 psi @ 0mA	5.05 ohms	3 – B Clutch; 7 – EPC
Black	MV2	Open/Closed	11.5 ohms	Park Lock Valve
Green	MV3	Open/Closed	24-26 ohms	Park Lock Cylinder

** = Found on some Audi applications

Ford Solenoid O-Ring Sizes Figure 16			
Connector Color	Snout Color	Inboard O-Ring Size	Outboard O-Ring Size
Ford 2007–2009: 6R60			
Brown	Long Black	10.5 x 2mm	13.5 x 2mm
Black	Long Black	10.5 x 2mm	13 x 2mm
Cream	White	OR-014	OR-016
Ford 2010–Later: 6R60			
Tan	Brown	10.5 x 2mm	13.5 x 2mm
Tan	Black	10.5 x 2mm	13 x 2mm
Tan (2010–2011)	White	OR-014	OR-016
Tan (2012–Later)	Gray	OR-014	OR-016



NOTE: TECH TIP: Solenoids in these units (especially the more active solenoids) commonly malfunction, leading to hydraulic control trouble, requiring solenoid replacement in many cases.

Ford Solenoid Function Figure 17				
Connector or Snout Color	Location	Output	Resistance at 68°F (20°C)	Function
Ford 2007–2009: 6R60				
Brown	SSA, SSC, TCC, VFS1, VFS3, VFS6	0 psi (0 bar) at 0 mA	5.05 ohms	1 – A Clutch; 3 – C Brake; 6 – TCC
Black	SSB, SSD, PCA, VFS2, VFS4, VFS5	67 psi (4.6 bar) at 0 mA	5.05 ohms	2 – B Clutch; 4 – D & E Clutch; 5 – EPC
Cream	SSE/SS1	Open/Closed	11.5 ohms	Solenoid Multiplex/Drive Enable Valve
Ford 2010 – Later: 6R60/6R80				
Brown	SSA, SSC, TCC, VFS1, CFS3, VFS6	0 psi @ 0 mA	5.05 ohms	1 – A Clutch; 3 – C Brake; 6 – TCC
Black	SSB, SSD, PCA, VFS2, VFS4, VFS5	67 psi (4.6 bar) at 0 mA	5.05 ohms	2 – B Clutch; 4 – D & E Clutch; 5 – EPC
Cream (2010–2011)	SSE/SS1	Open/Closed	11.5 ohms	Solenoid Multiplex/Drive Enable Valve
Gray (2012–Later)	SSE/SS1	Open/Closed	18 ohms	Solenoid Multiplex/Drive Enable Valve