

GM 6L45, 6L50, 6L80, 6L90 ZIP KIT®

PART NUMBER 6L45-6L90-ZIP

IDENTIFICATION GUIDE

Valve Body Casting Identification

Look for the machined-down boss on the upper valve body (**Figure 1**). Generally, if the “A” boss is machined down, this indicates an MYA/6L45 unit (see chart below). This identification system is not foolproof, because on some valve bodies none of the bosses are machined down (**Figure 2**). Also see other early vs. late and 6L45/50 vs. 6L80/90 application differences (**Figure 3**).

Machined-Down Boss on Upper Valve Body	Indicates Valve Body Unit*
“A” Boss ID	MYA/6L45
“B” Boss ID	MYB/6L50
“C” Boss ID	MYC/6L80
“D” Boss ID	MYD/6L90

*Note: This is a general rule to follow, but may not always be true. Sometimes no bosses are machined.

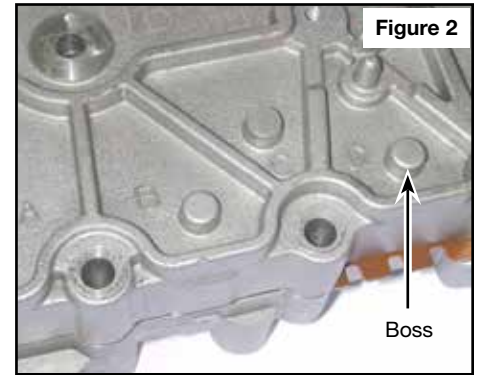
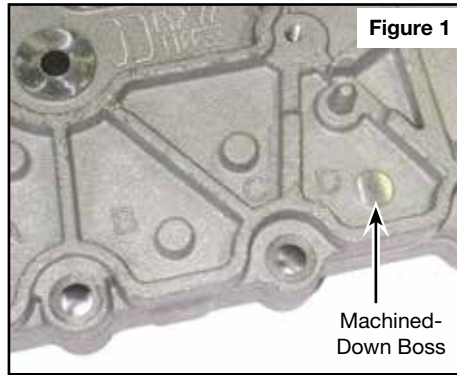

		Upper Casting		Center Support Feed Holes	Lower Casting	
		'10- Earlier	'10- Later		'10- Earlier	'10- Later
GM	6L45	9405	7114	Centered	9581	0945
	6L50	9405	7117	Centered	9581	0945
	6L80	9404	0955	Offset Front	9581	0945
	6L90	9404	0955	Offset Rear	9581	0945
BMW	6L45	1590		Centered	9581 or 6351	

EARLY Valve Body (6L80 Shown)

6L80: Four holes offset to front.
6L90: Four holes offset to rear.

With exhaust ports in 2010-earlier units, use 24245720 separator plate.

ISS and OSS bosses short on the 6L80 and 6L90.

LATE Valve Body (6L50 Shown)

6L45, 6L50: Four holes are centered in machined area.

No exhaust ports in 2010-later units.

ISS and OSS bosses tall on the 6L45 and 6L50.

Separator Plate Identification

Clutch Select Spring Usage

Refer to A and B below and in illustration (Figure 4) to identify early 1st design plate that does not use supplied clutch select springs.



NOTE: All other plate designs can use supplied springs.

A. If Early, 1st design 6L80 plate 24246916 is equipped, REPLACE with Early, 2nd design plate 24245720 and install Sonnax clutch select valve spring kit 104740-02K.

B. When using Early, 2nd design plate (2010-Earlier, OE part #24245720): DO NOT install checkball #8.

#8 Checkball Usage

Reference images C and D (Figure 4) for orifice location and size in determining if #8 checkball is used.

See location of #8 checkball on 6L80/90 models only, when necessary (Figure 5).

NOTE: OE separator plate part numbers are correct as of this printing. Sonnax recommends confirming part numbers with dealer as part supersession is common.

Figure 4

A. Early, 1st Design Plate

(OE 24246916)

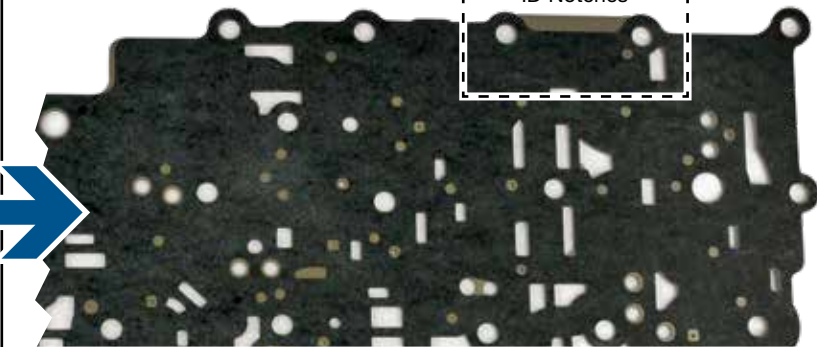

B. Early, 2nd Design Plate

(OE 24245720)

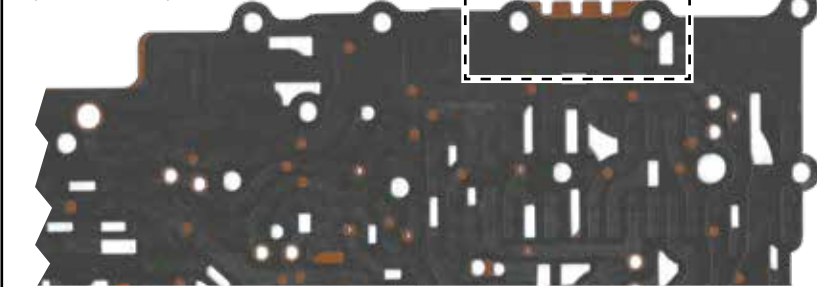

C. No #8 Checkball

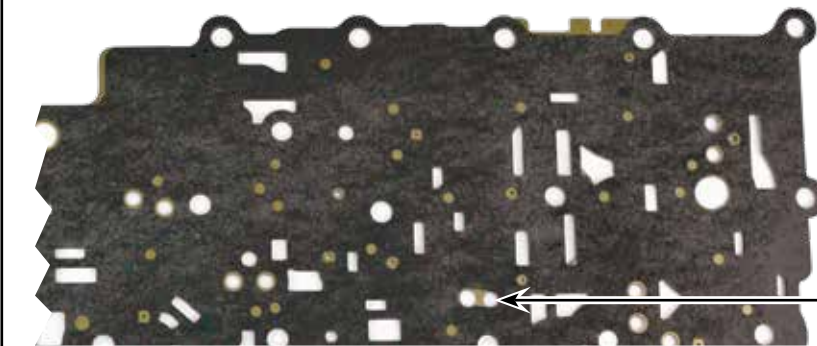

D. Requires #8 Checkball



Figure 5



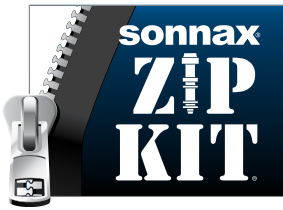

GM 6L45, 6L50, 6L80, 6L90 ZIP KIT®

PART NUMBER 6L45-6L90-ZIP

QUICK GUIDE

Parts are labeled here in order of installation. See other side of sheet for details on kit contents.

INSTALLATION DIAGRAM

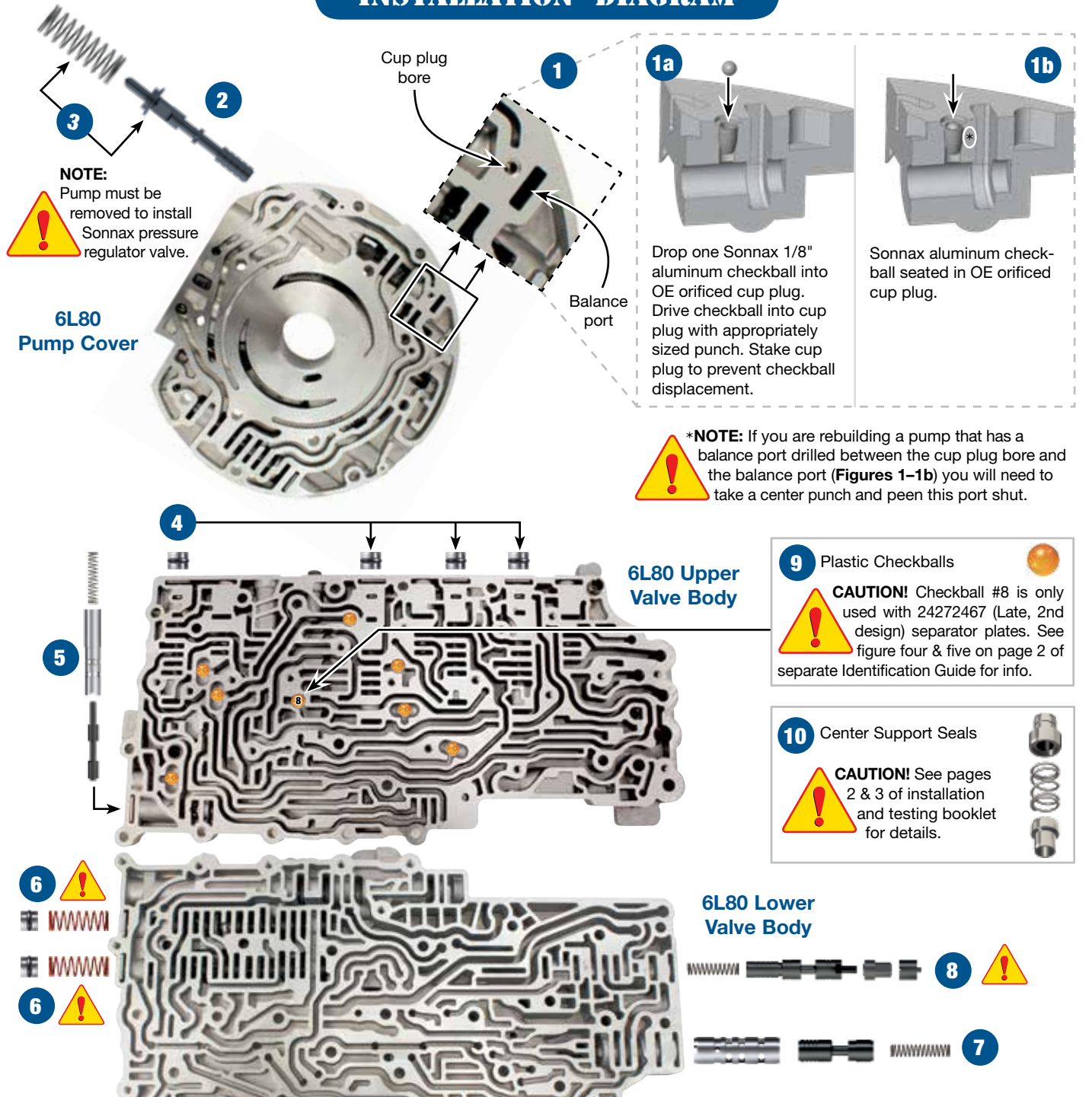

In addition to general rebuilding tips and technical information, the technical booklet included in this kit contains vacuum testing and additional repair options for higher mileage units or for repairing specific complaints which are beyond the scope of this kit.

Kit Contents & Installation Steps

Step 1 Reroute Pressure Regulator Valve Balance Feed

NOTE: Pump must be removed to install Sonnax pressure regulator valve. Remove all components from bore prior to proceeding. The following steps are required for use of Sonnax valve.

Drop the checkball into OE orificed cup plug. Drive checkball into cup plug with appropriately sized punch. Stake cup plug to prevent checkball displacement.

 **NOTE:** If you are rebuilding a pump that has a balance port drilled between the cup plug bore and the balance port (Figures 1-1b) you will need to take a center punch and peen this port shut.

Packaging Pocket 1

- Checkball, 1/8"

Step 2 Replace Pressure Regulator Valve

Packaging Pocket 2

- Valve
- Spring

Step 3 Replace OE Boost Assembly

Packaging Pocket 3

- Valve
- Sleeve

Step 4 Replace Upper Valve Body OE End Plugs

Place O-ring in groove, lubricate with Sonnax Slippery Stick™ O-LUBE and roll on bench to size.

Packaging Pocket 4

- End Plugs (4)
- O-Rings (6) 2 Extra

Step 5 Replace OE Actuator Feed Limit Valve

Sleeve installs with end grooves inboard. Valve installs with spring stem outboard.

Packaging Pocket 5

- Valve
- Sleeve
- Spring

Step 6 Replace Clutch Select Valve #2 & #3 Springs & End Plugs

 Sonnax clutch select valve springs can be used with all OE separator plates EXCEPT separator plate 24246916 (Early, 1st design 6L80 plate). If separator plate 24246916 is equipped, it must be upgraded with OE plate 24245720 (Early, 6L80 2nd design) to prevent code P0751, shift concerns and burnt/slipping 1-2-3-4 and/or 3-5-Reverse clutches. See Figures 3 and 4 on separate Identification Guide for information.

NOTE: Sonnax clutch select springs can be used on 6L45/50 models.

Packaging Pocket 6

- Springs (2)
- End Plugs (2)
- O-Rings (3) 1 Extra

Step 7 Replace Compensator Feed Regulator Valve

Sleeve installs with end grooves inboard. Valve installs with spring pocket outboard.

Packaging Pocket 7

- Valve
- Sleeve
- Spring

Step 8 Replace TCC Regulator Valve Lineup

 Clocking/Rotational alignment of components are critical. See page 2 of installation and testing booklet for details.

Packaging Pocket 8

- Spring
- TCC Regulator Valve
- Shuttle Valve
- End Plug

Step 9 Replace OE Checkballs

Packaging Pocket 9

Checkballs, .250" dia. (8)

NOTE: Not all checkballs used on all castings. See warning on page 1 of this Quick Guide.

Step 10 Install Center Support Seals

 See pages 2 & 3 of installation and testing booklet for details.

Packaging Pocket 10

- Seal Inserts (8)
- Springs (6)

Step 11 Vacuum Testing

Use nut for testing pump body pressure regulator valve. Block valve outboard as shown on page 5 of installation and testing booklet. Remove nut after testing.

Packaging Pocket 11

- Nut, .125"

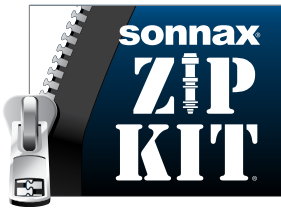

GM 6L45, 6L50, 6L80, 6L90 ZIP KIT®

PART NUMBER 6L45-6L90-ZIP

INSTALLATION & TESTING BOOKLET



Cautions

Control Solenoid Valve Assembly

Use care when handling the control solenoid valve assembly (valve body and TCM or TEHCM). If dropped, roughly handled, or exposed to excessive dust and debris, damage could occur to the TEHCM. A thorough inspection and cleaning of the TEHCM should be included in any rebuild procedure, and is detailed on page 3.

The control solenoid valve assembly must be removed prior to removing the converter housing and pump assembly. Severe component damage will result if not followed.

Fast Learn Adapts

Following installation of the Zip Kit, the Service Fast Learn Adapts procedure must be performed. Follow instruction on the scan tool or reference OE specifications for details on the procedure.

Zip Kit Instructions

1. Remove & Disassemble the Control Solenoid Valve Assembly

- Remove six control solenoid valve assembly-to-case Torx Plus® bolts (**Figure 1 & 2**). A special socket (GM Tool Part No. DT-48285) is available (**Figure 3**), or a standard 1¹/₂" six-point drive socket will work with care.
- Remove two bolts (8mm head) and input/output speed sensor assembly (**Figure 4**).
- Remove the single 8mm head bolt and manual shaft detent assembly. Release the position switch assembly connector, remove the single 10mm head bolt, then remove the position switch assembly (**Figure 5**).
- Remove the two 8mm head bolts on the side of the TEHCM (**Figure 6**).
- Remove the four 10mm head and five 7mm head bolts (**Figure 7**). Remove the TEHCM and set aside for inspection, testing and cleaning.
- Remove the 12, 7mm head bolts (**Figure 8**).
- Remove the five 7mm head bolts and single 10mm head bolt. The valve body halves may now be separated from each other (**Figure 9**).

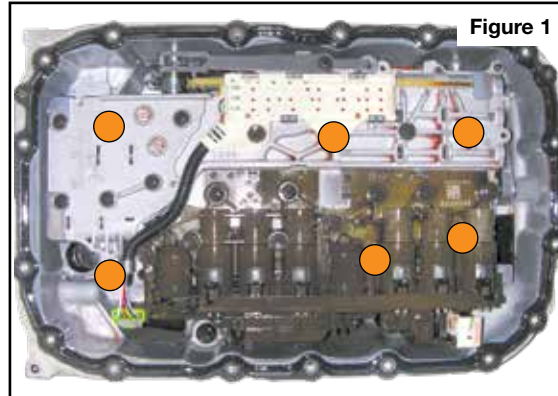

Figure 1



Figure 2

Torx Plus® Bolt

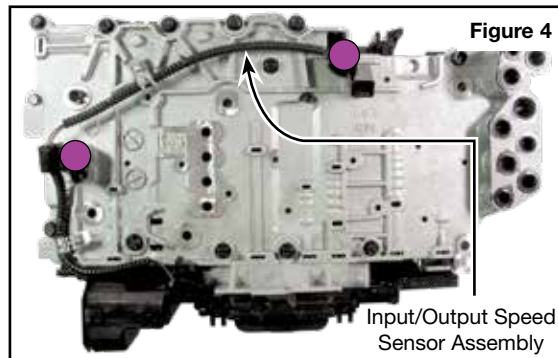

Figure 4

Input/Output Speed Sensor Assembly



Figure 3

GM Tool DT-48285

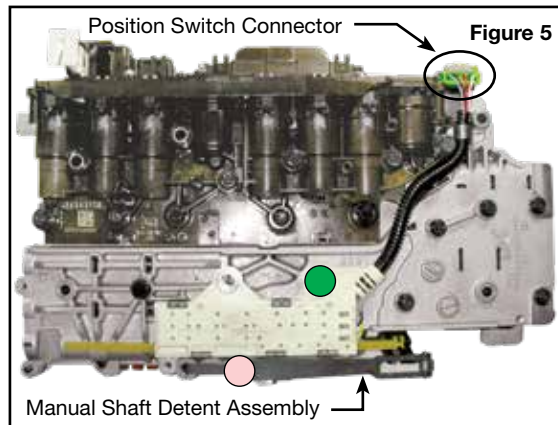

Figure 5

Manual Shaft Detent Assembly

Bolt Color Code	Bolt Length	Bolt Head
Yellow	36mm	7mm
Orange	73mm	TorxPlus
Red	45mm	7mm
Green	55mm	10mm
Blue	53mm	8mm
Purple*	20mm	8mm
Pink*	14.5mm	8mm

Note: Torque all bolts at 71 in-lb, except (*) pink & purple should be torqued at 106 in-lb.

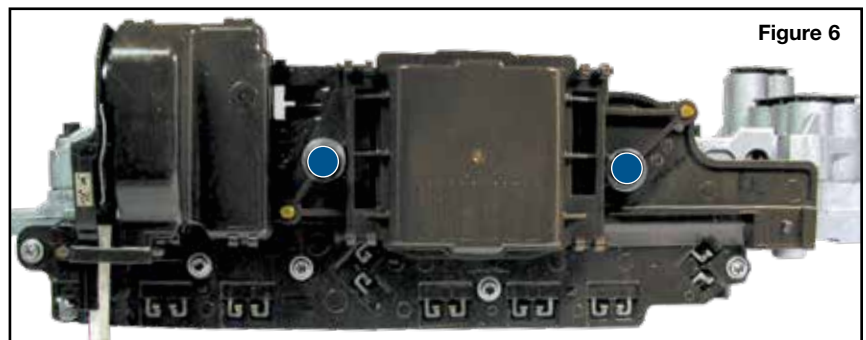

Figure 6

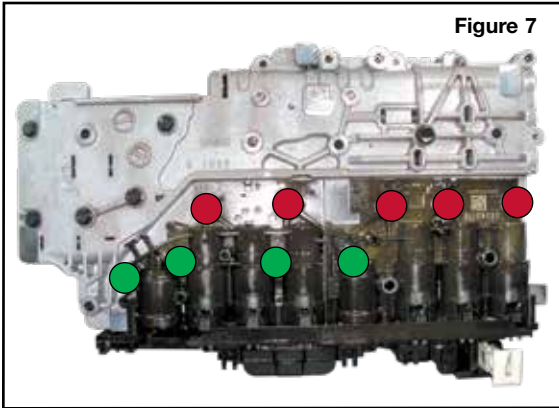

Figure 7

Zip Kit Instructions (continued)

2. Pump Disassembly & Assembly

Remove 13 pump-cover-assembly-to-torque-converter-housing bolts. For reassembly, torque bolts in the sequence shown to 97 in-lb (Figure 10).

3. Installation

Install Zip Kit parts as shown on diagram of separate quick guide sheet included in this Zip Kit. Sonnax recommends vacuum testing critical wear areas not covered by this kit to determine whether additional Sonnax parts are required (see pages 5–6).

Zip Kit Quick Guide Details

1. Replace TCC Regulator Valve Lineup

Clocking/rotational alignment of components from step 8 is critical, see diagram for proper alignment (Figure 11).

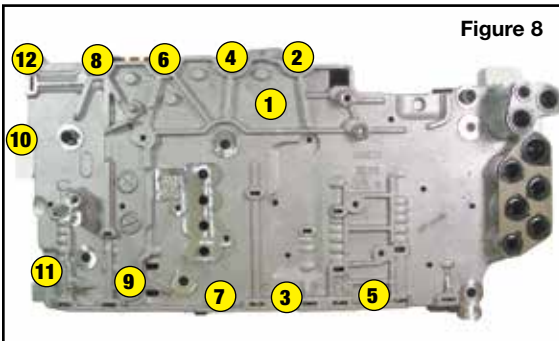

Figure 8

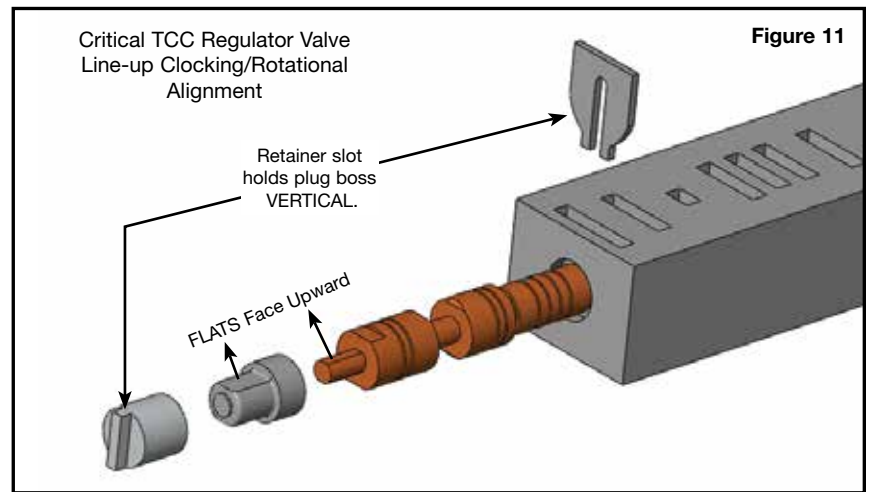

Figure 11

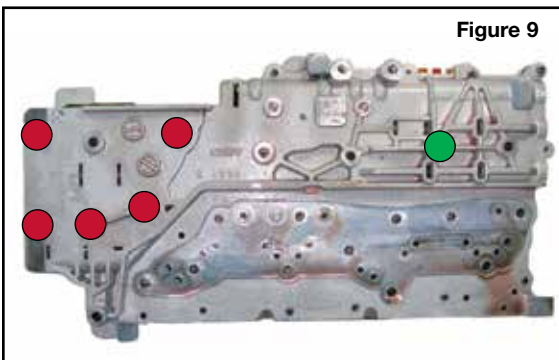

Figure 9

2. Center Support Seal Reinforcement Insert Installation

- Install four Sonnax valve body seal inserts (non-grooved, non-threaded) into the back side of valve body. Use appropriately sized flat punch to lightly tap inserts into place. Shoulder on insert will seat flush against the finished valve body surface (Figure 12).
- Remove OE center support seal assembly from case and set aside for reuse (Figure 13).
- Install four Sonnax case seal inserts (grooved and threaded) into the case at the center support location (Figure 14). Use appropriately sized flat punch to lightly tap inserts into place. Shoulder on insert will seat flush.



TECH TIP: Threads are provided for removal of case inserts when necessary to allow center support removal.

- Reinstall OE center support seals over Sonnax case seal inserts.



NOTE: 6L45 and 6L50 center support seals are approximately .900" tall (outer) and .730" tall (inner). 6L80 and 6L90 unit seals are shorter, approximately .590" tall (outer) and .420" tall (inner) (Figure 15).

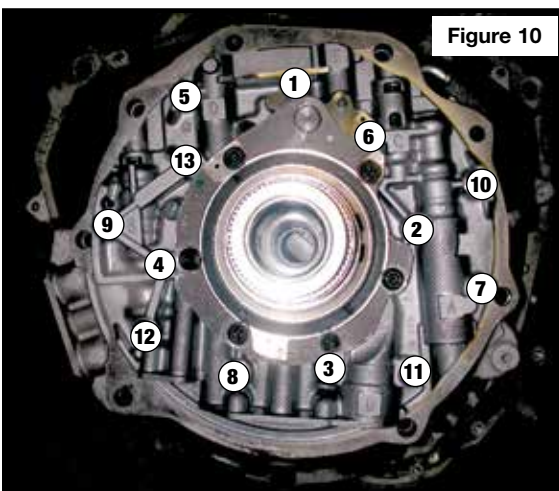

Figure 10

e. Install appropriate Sonnax springs into OE seals as described below, then secure springs by trapping them in seals with assembly lube (Figure 16).

For 6L45/6L50 seals:

- Insert tall (.560") Sonnax springs in tall outer seals.
- Insert medium (.380") Sonnax springs in shorter middle seals.

For 6L80/6L90 seals:

- Insert short (.250") Sonnax springs in tall outer seals.
- NO springs required in shorter middle seals.

f. After reassembling TEHCM to valve body (Step 5 below), install valve body into case. Ensure the four Sonnax valve body inserts slide into the OE center support seals before installing valve body fasteners.

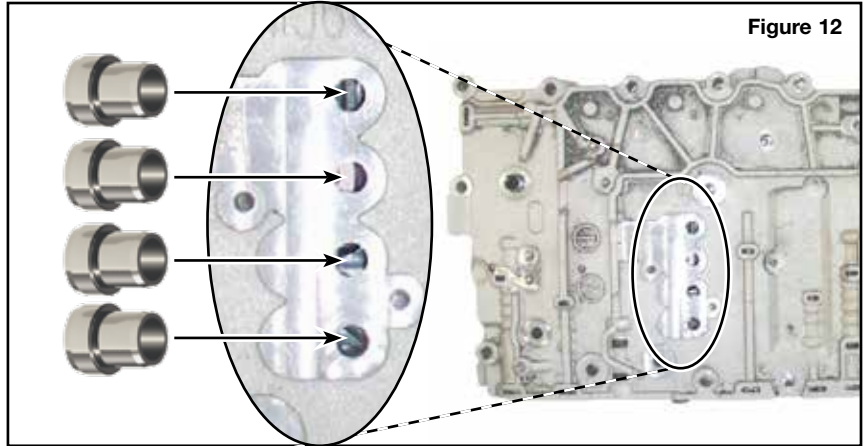

Figure 12

3. TEHCM Inspection & Cleaning

The TEHCM is continually immersed in transmission oil and exposed to debris generated during transmission operation. This debris can create malfunction of the TEHCM and its components if not cleaned thoroughly. Clean with shop air, but do not use a rag or cloth, as lint will contaminate the TEHCM (Figure 17).

- Remove and replace filter plate assembly (Figure 18). This part must be replaced any time the control solenoid valve assembly had been removed, as the seals take a set.
- Debris can easily collect in the solenoid cavities, supply and control ports. Examine these locations carefully and apply 30 psi regulated shop air to remove debris. Also check the 16-way connector, TFT sensor and ISS/OSS connector for debris (Figure 19).
- Inspect the 16 solenoid electrical contact leads and IMS connector for debris and clean if necessary (Figure 20).
- If problems are found with pressure switch seals or laminate discs, Sonnax offers pressure switch rebuild kits, available separately (Figure 21).

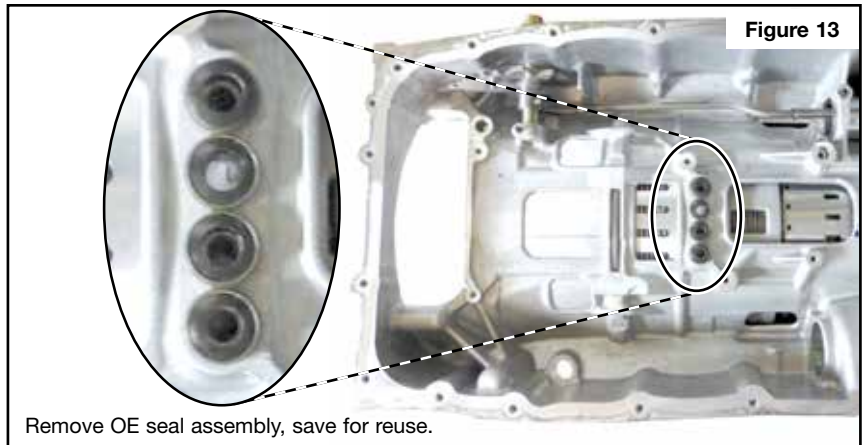

Figure 13

Remove OE seal assembly, save for reuse.

4. TEHCM Testing

The TEHCM can be tested, although this requires special tools and the vehicle for communication with the data bus. Reference “Bench Testing the 6L50-6L80-6L90-6T70-6T75 TEHCM” by Steve Garrett in August 2012 *Gears* or OE specifications for details.

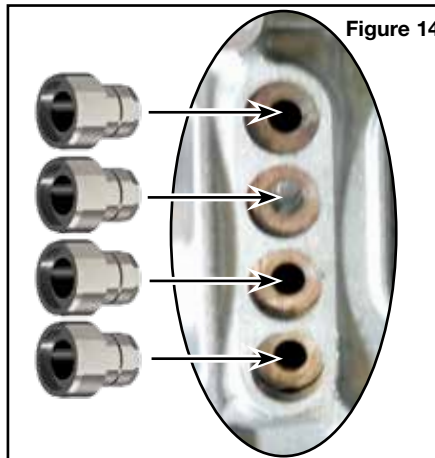

Figure 14

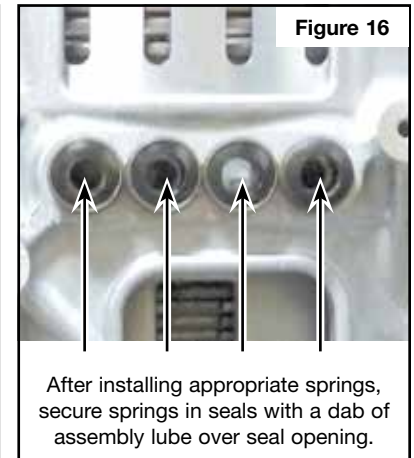

Figure 16

After installing appropriate springs, secure springs in seals with a dab of assembly lube over seal opening.

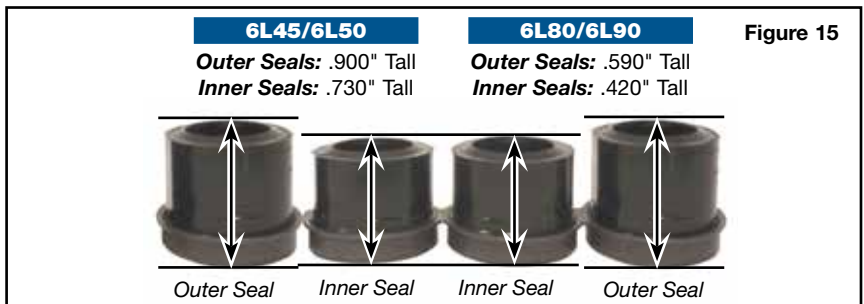
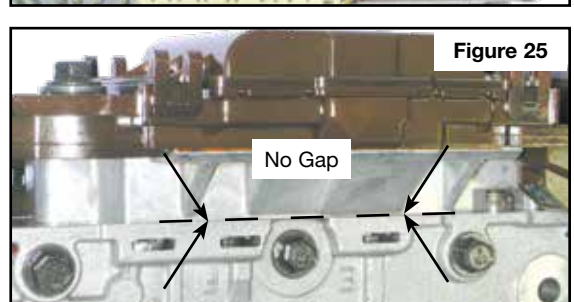
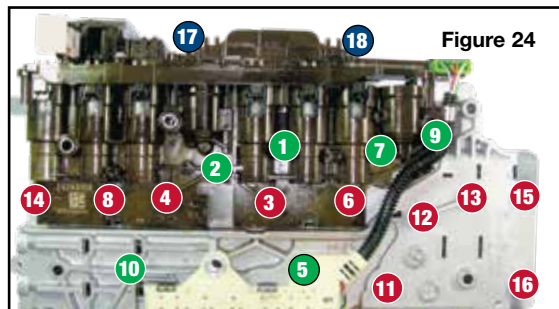
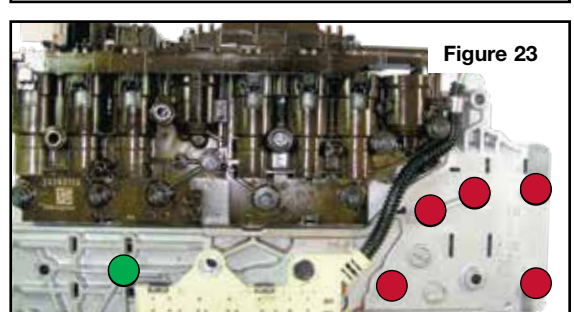
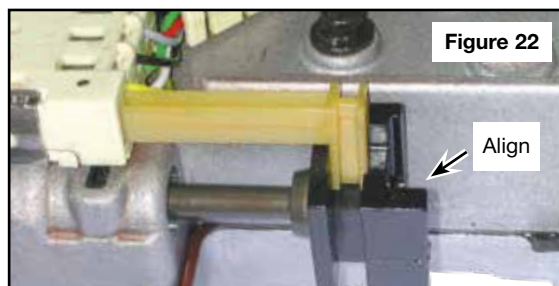
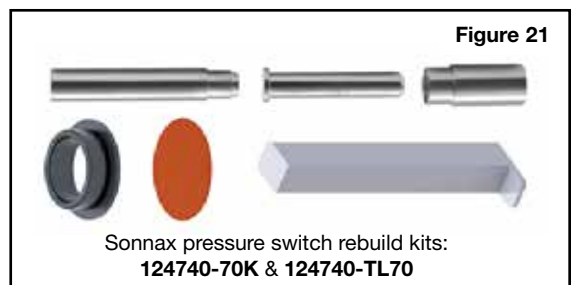
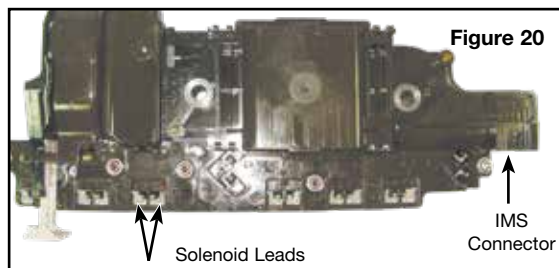
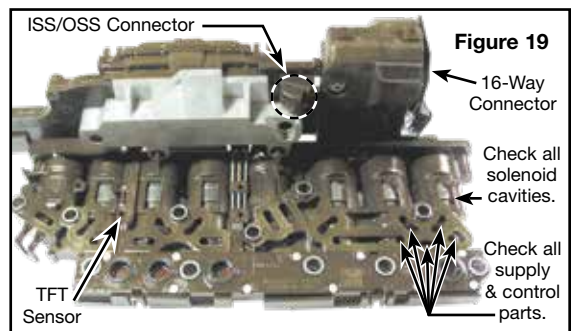
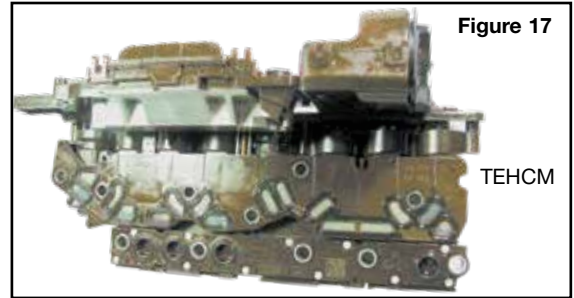

Figure 15

5. Reassemble Control Solenoid Valve Assembly

It is important to follow the assembly and torque sequence as well as torque ratings indicated in the bolt chart to ensure proper function of the control solenoid valve assembly.

- a. Install the 12, 7mm head bolts and torque to 71 in-lbs. in sequence shown (Figure 8).
- b. Place the TEHCM on the valve body. Install the two 8mm head bolts and *hand-tighten only* (Figure 6).
- c. Install the four 10mm head and five 7mm head bolts and *hand-tighten only* (Figure 7).
- d. Reconnect the position switch connector and align the switch activator slide with the manual valve link as shown. Secure the assembly to the casting with the 10mm head bolt and *hand-tighten only* (Figures 5 & 22).
- e. Install the five 7mm head bolts and single 10mm head bolt and *hand-tighten only* (Figure 23).
- f. Tighten all 18 bolts in the sequence indicated to 71 in-lb. Bolts 17 and 18 are on the side of the TEHCM (Figure 24).
- g. Inspect the contact area between the aluminum portion of the TEHCM and the valve body casting. There should be no visible gap. If a gap is found, loosen all 18 bolts in step “f” and re-torque until no gap exists (Figure 25).
- h. Reconnect the input/output speed sensor connector and torque the two bolts to 106 in-lb (Figure 4).
- i. Reinstall the manual shaft detent assembly and torque the bolt to 106 in-lb (Figure 5).



Critical Wear Areas & Vacuum Test Locations



Drop-In Zip Valve™
Parts Available

NOTE: OE valves are shown in rest position and should be tested in rest position unless otherwise indicated. Test locations are pointed to with an arrow. Springs are not shown for visual clarity. Low vacuum reading indicates wear and Sonnax parts are noted for replacement.

NOTE: The 104740-VTP vacuum test plate kit (VTP) can be used, but the plates do not check for wear in the pump body. Check these locations using the small test plate and sealing pad included in the VACTEST-01K.



For specific vacuum test information, refer to individual part instructions included in kits and available at www.sonnax.com.

Converter Feed Limit Valve

- High TCC slip RPM • Overheated converter
 - Codes P0218/P0741 • Inadequate lubrication
 - Excess converter pressure
- NOTE:** Must test with actuator feed limit (AFL) valve instead of converter limit valve. Position AFL valve so spool face and port face are flush as indicated.

Replace with Sonnax Part No. **104520-11** Requires F-104520-TL11C & VB-FIX

Test using AFL Valve (#209)

Remove Converter Limit Valve

Flush

TCC Control Valve

- No lockup
 - Falling out of lockup hot
 - Lockup codes
- NOTE:** Test at valve port while plugging side port with thumb.

Plug Here

Pump Body 6L80 Shown

Pressure Regulator Valve

- Erratic/High/Low line pressure
 - Clutch slippage • Harsh shifts
 - Low/No cooler flow • Soft shifts
 - Overheated transmission • Converter concerns
- NOTE:** Block outboard as shown with .125" thick nut. Remove nut after testing.

Replace with Sonnax Part Nos. **104520-15K*** or **104520-16K** Requires F-104520-TL7C, VB-FIX & VB-06

Block with .125" nut

Boost Assembly

- Low line rise in Drive
 - Soft shifts • Burnt clutches
- NOTE:** Test both ports simultaneously.
- Replace with Sonnax Part No. **104520-12K***

Clutch Select Valve #3

Shift complaints

Lower Valve Body 6L80 Shown

TCC Regulator Apply Valve

- Code P0741/P0742 • Failsafe mode
 - Overheated fluid • High TCC slip RPM
 - Harsh shifts • Harsh TCC apply
- NOTE:** Test with .125" thick nut between shuttle valve and regulator valve.

Replace with Sonnax Part Nos. **104740-46K** or **104740-07K** Requires F-104740-TL7 & VB-FIX

Clutch Select Valve #2

Shift complaints

Compensator Feed Valve

- Harsh shifts • Downshift clunk
 - Bump/Flare shifts • Bind-up
 - Burnt clutches • Overheated fluid
- Replace with Sonnax Part No. **104740-09K***

Part numbers with an asterisk () are included in this Zip Kit.

Critical Wear Areas & Vacuum Test Locations



Drop-In Zip Valve™
Parts Available

NOTE: OE valves are shown in rest position and should be tested in rest position unless otherwise indicated. Test locations are pointed to with an arrow. Springs are not shown for visual clarity. Low vacuum reading indicates wear and Sonnax parts are noted for replacement.

Upper Valve Body • 6L80 Shown

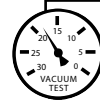

For specific vacuum test information, refer to individual part instructions included in kits and available at www.sonnax.com.

1-2-3-4 Clutch Regulator & Shuttle Valve

- Burnt clutches
- Shift concerns in 1st, 2nd, 3rd & 4th Gear

1-2-3-4 Clutch Boost Valve

- Shift quality is not load sensitive
- Burnt clutches
- Clutch pressure solenoid codes
- Delayed engagement

Replace with Sonnax Part No. 104740-01 Requires F-104740-TL & VB-FIX

End Plugs

- Burnt clutches
- Shift concerns

NOTE: Test end plugs at port between valve and end plug.

Replace with Sonnax Part No. 104740-23K*

NOTE: Several Locations = ★

3-5 Reverse Clutch Regulator Valve

- Burnt 3-5 Reverse clutch
- Delayed/No Reverse
- 3rd & 5th Shift concerns

3-5 Clutch Boost Valve

- Shift quality is not load sensitive
- Clutch pressure solenoid codes
- Burnt clutches
- Slip codes
- Delayed engagement

Replace with Sonnax Part No. 104740-01

Requires F-104740-TL & VB-FIX

4-5-6 Clutch Boost Valve

- Shift quality is not load sensitive
- Clutch pressure solenoid codes
- Burnt clutches
- Slip codes
- Delayed engagement

Replace with Sonnax Part No. 104740-01

Requires F-104740-TL & VB-FIX

Actuator Feed Limit Valve

- Solenoid performance codes
- Clutch failure
- Wrong gear starts
- Harsh/Soft shifts

Replace with Sonnax Part Nos. 104740-47K or 104740-12 Requires F-104740-TL12 & VB-FIX

2-6 Clutch Regulator & Gain Valves

- Burnt 2-6 clutch
- Shift concerns in 2nd & 6th Gear

CBR1/4-5-6 Clutch Regulator Valve

- Burnt 4-5-6 clutch
- Shift concerns in 4th, 5th & 6th Gear

Insets shown with end plugs removed for clarity only. Test with end plugs installed.

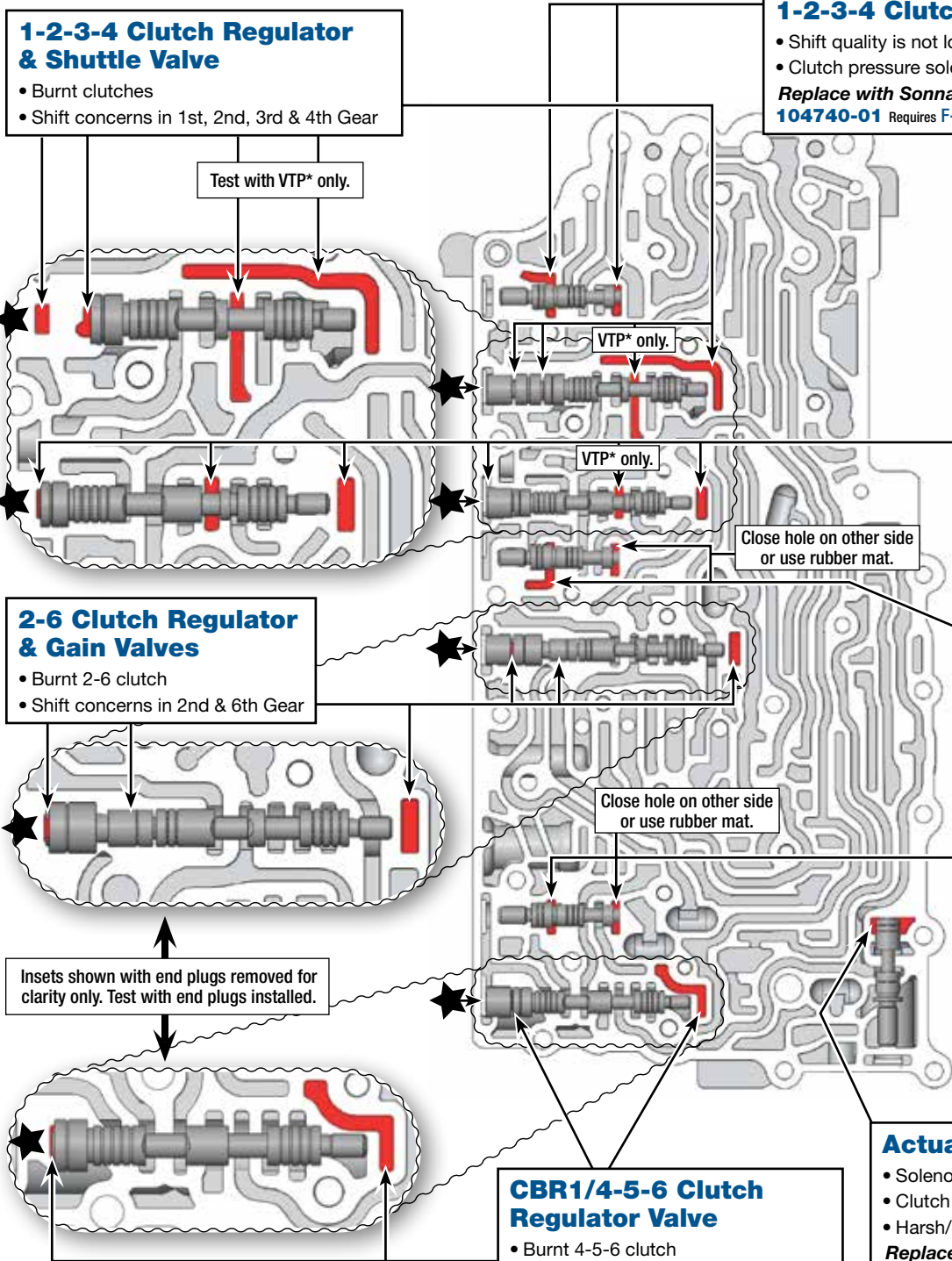

Part numbers with an asterisk () are included in this Zip Kit.

OE Exploded View

Pump & Lower Valve Body • 6L80 Shown

NOTE: Depending upon vehicle application, the OE springs shown may not be present.

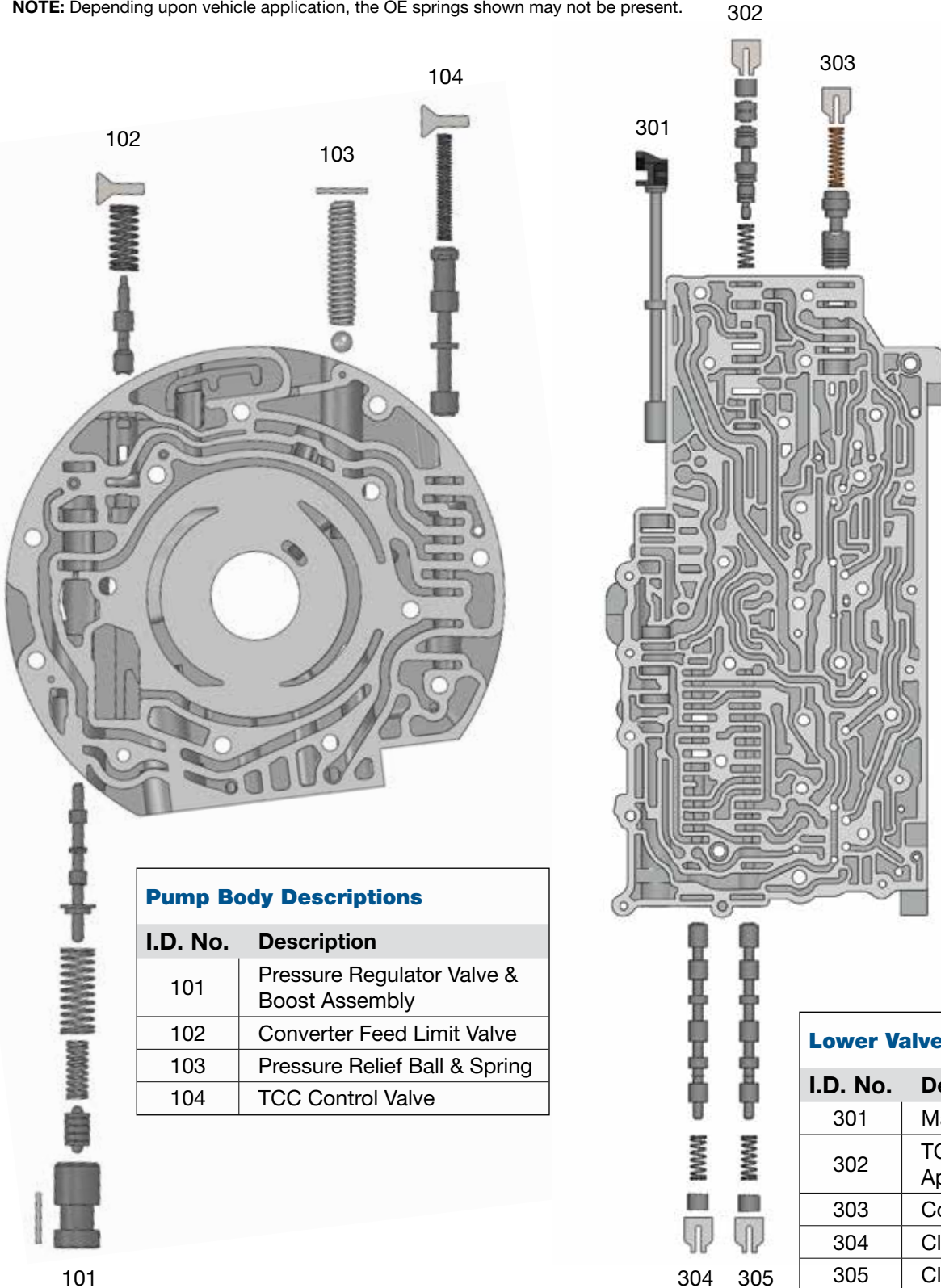

Pump Body Descriptions

I.D. No.	Description
101	Pressure Regulator Valve & Boost Assembly
102	Converter Feed Limit Valve
103	Pressure Relief Ball & Spring
104	TCC Control Valve

Lower Valve Body Descriptions

I.D. No.	Description
301	Manual Valve
302	TCC Regulator Apply Valve
303	Compensator Feed Valve
304	Clutch Select Valve #3
305	Clutch Select Valve #2

OE Exploded View

Upper Valve Body • 6L80 Shown

NOTE: Depending upon vehicle application, the OE springs shown may not be present.

Upper Valve Body Descriptions	
I.D. No.	Description
201	1234 Clutch Boost Valve
202	1234 Clutch Regulator & Shuttle Valve
203	3-5 Reverse Clutch Regulator Valve
204	3-5 Reverse Clutch Boost Valve
205	2-6 Clutch Regulator & Gain Valves
206	Exhaust Backfill Pressure Relief Valve
207	456 Clutch Boost Valve
208	CBR1/C456 Clutch Regulator Valve
209	Actuator Feed Limit Valve

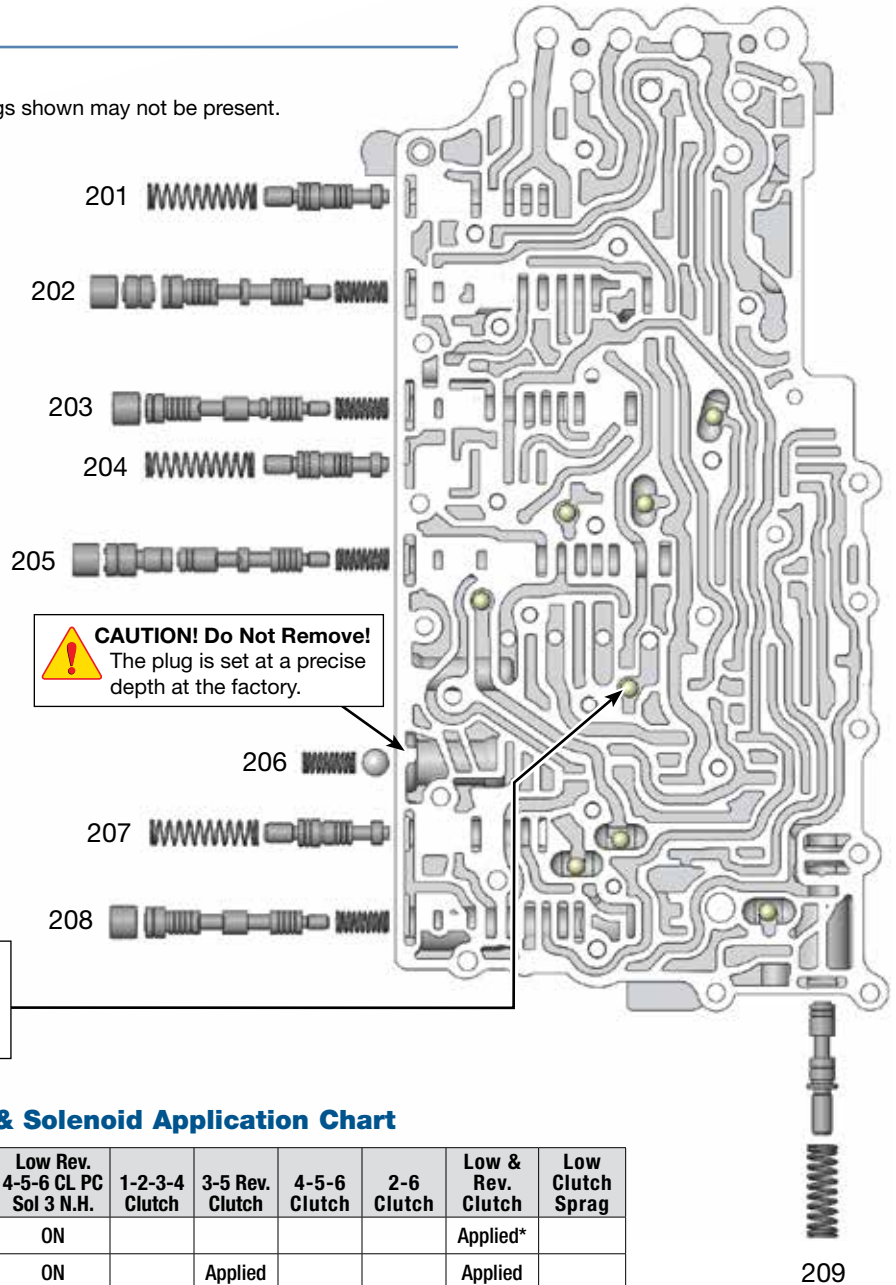

CAUTION! Checkball #8 is only used with 24272467 (Late, 2nd design) separator plates. See separate identification guide for info.

GM 6L45-6L90 Clutch & Solenoid Application Chart

Gear Range	Shift Sol 1	Shift Sol 2	1-2-3-4 CL PC Sol 5 N.L.	2-6 CL PC Sol 4 N.L.	3-5 Rev. CL PC Sol 2 N.H.	Low Rev. 4-5-6 CL PC Sol 3 N.H.	1-2-3-4 Clutch	3-5 Rev. Clutch	4-5-6 Clutch	2-6 Clutch	Low & Rev. Clutch	Low Clutch Sprag
Park	ON	ON	OFF	OFF	OFF	ON					Applied*	
Reverse	ON	OFF	OFF	OFF	ON	ON		Applied			Applied	
Neutral	ON	ON	OFF	OFF	OFF	ON					Applied*	
D-1st Braking	ON	ON	ON	OFF	OFF	ON	Applied				Applied	Holding
D-1st	OFF	ON	ON	OFF	OFF	OFF	Applied					Holding
D-2nd	OFF	ON	ON	ON	OFF	OFF	Applied			Applied		
D-3rd	OFF	ON	ON	OFF	ON	OFF	Applied	Applied				
D-4th	OFF	ON	ON	OFF	OFF	ON	Applied		Applied			
D-5th	OFF	ON	OFF	OFF	ON	ON		Applied	Applied			
D-6th	OFF	ON	OFF	ON	OFF	ON			Applied	Applied		

Notes:
 For shift solenoids 1 and 2, "ON" = Solenoid Energized (Pressurized), "OFF" = Solenoid De-energized (No Pressure).
 For pressure control (PC) solenoids, "ON" = Pressurized, "OFF" = No Pressure.
 * = Applied with No Load.