

Vacuum Test Plate Kit

Part No.

104740-VTP



- Upper Plate
- Lower Plate
- Seals (2)
- Push Pins (14) 2 Extra
- Alignment Pins (2)
- Bolts (4)
- Washers (4)
- Wing Nuts (4)

Vacuum Test Stand Kit

Part No.

VACTEST-01K

- Vacuum Test Stand
- Test Plate
- Vacuum Plate Sealing Pad
- Vacuum Test Foam Pad
- Push-to-Connect Fitting
- Assorted Testing Tips (6)
- Testing Tip Adapter Tube
- Flexible Tubing
- Flared Tubing with Flared Nut

Instructions

1. Assembly

- a. Ensure vacuum test plate and seal are both clean and free of debris.
- b. Install two alignment pins into lower valve body plate at indicated threaded holes. Thread into non-engraved side of plate (**Figure 1**). The upper valve body plate has two holes that align with the OE dowel pins in the casting.
- c. Place seal onto non-engraved side of plate, aligning orifice holes. Remove any entrapped air between plate and seal by peeling seal up at plate edge. Gradually place seal back on plate from center toward edge.
- d. Push plastic push pins into seal and plate from seal side, just far enough for head to lightly contact seal.

NOTE: Sonnax recommends starting with only four corner locations. If seal sags away from plate, other push pin locations should also be used.

2. Testing

- a. Place assembled vacuum test plate over casting, using engraved casting outline as guide. Alignment pins should enter casting bolt holes.
- b. Using Sonnax vacuum test stand kit **VACTEST-01K** (sold separately, **Figure 2**) and small vacuum tip, vacuum test at numbered orifices on plate. These numbers correspond to the bore numbers called out in the exploded view of the valve body on page 6. The chart on page 8 provides descriptions of individual circuit checked and space to document actual vacuum readings and minimum vacuum standards.

NOTE: Vacuum Test Data Sheet on page 7 can be used to establish minimum vacuum standards at individual bore locations.

- c. Light finger-tip pressure may need to be applied on plate during testing. Included bolts, washers and wing nuts can be used at indicated bolt locations for firmer seal, but are not required. If used, place bolts through casting, seal and plate from the back of casting. Tighten wing-nut against plate, finger-tight only.

3. Cleaning

Seal and plate can be cleaned as needed with mild soap and water to remove debris.

4. What should my vacuum test results be?

While a properly calibrated and maintained test stand will give consistent vacuum reading results for a specific circuit and amount of wear, evaluating these results requires establishing your own pass/fail criteria. Variables which influence vacuum readings are the number of spools tested in a captive circuit, spool diameter size and contact length of the spool within the bore.

Pass/Fail standards are specific to your setup and process, but they also must be based on your experience, quality sensitivity, warranty concerns and cost/pricing structure. Sonnax recommends that you keep a record of vacuum results for each valve body at each tested circuit/port location. This lets you compare results over time to help determine for your shop what an acceptable vacuum reading is for each circuit/port location.

A chart specific to this application is provided in this booklet indicating valve and circuit checked at each orifice location. Room is provided to record results and compare to your minimum vacuum standard. A generic vacuum test data sheet also is provided that can be used to evaluate multiple cores to establish your minimum vacuum standard. These documents can be printed or downloaded and stored on your computer.

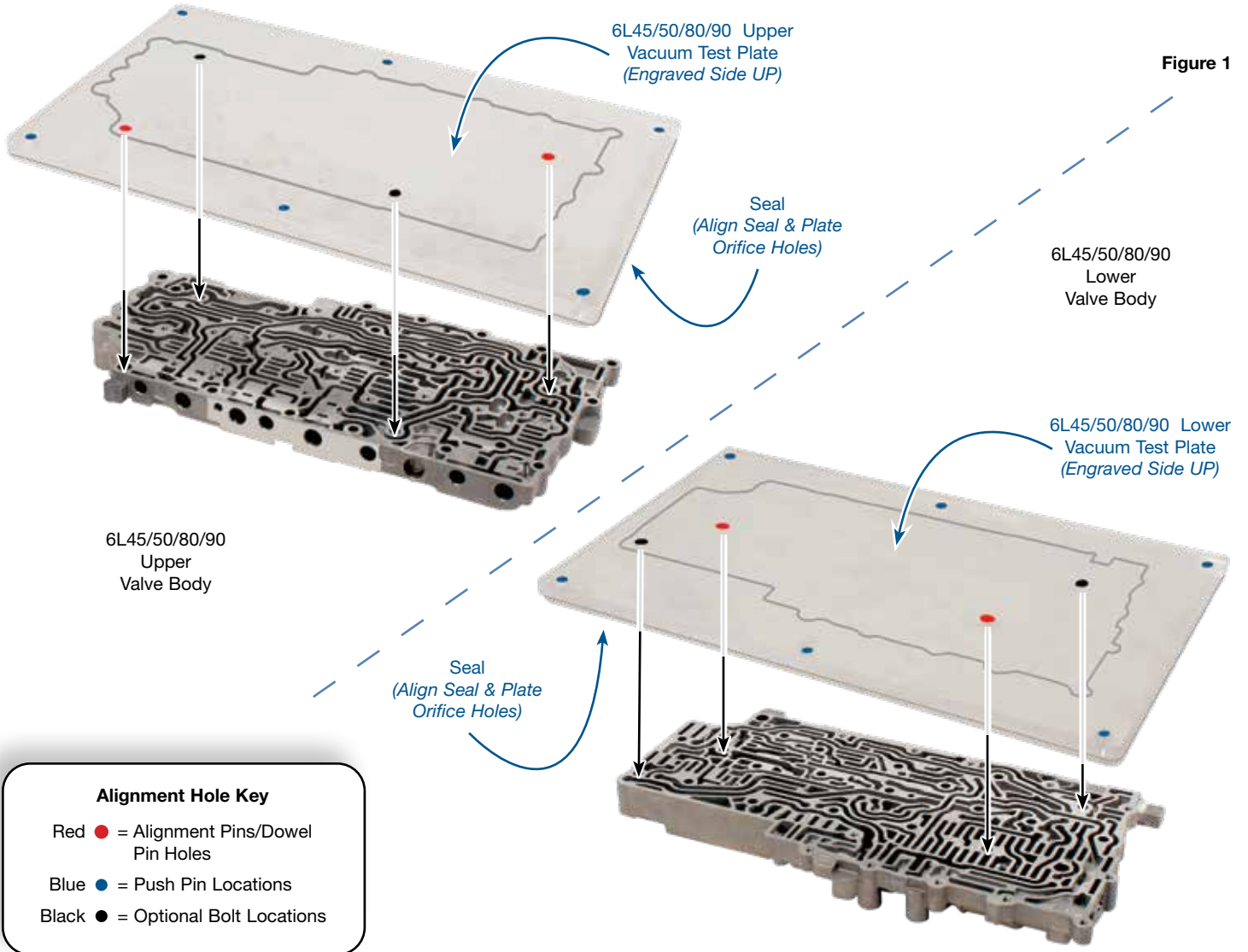

Figure 1

Vacuum Test Stand Kit

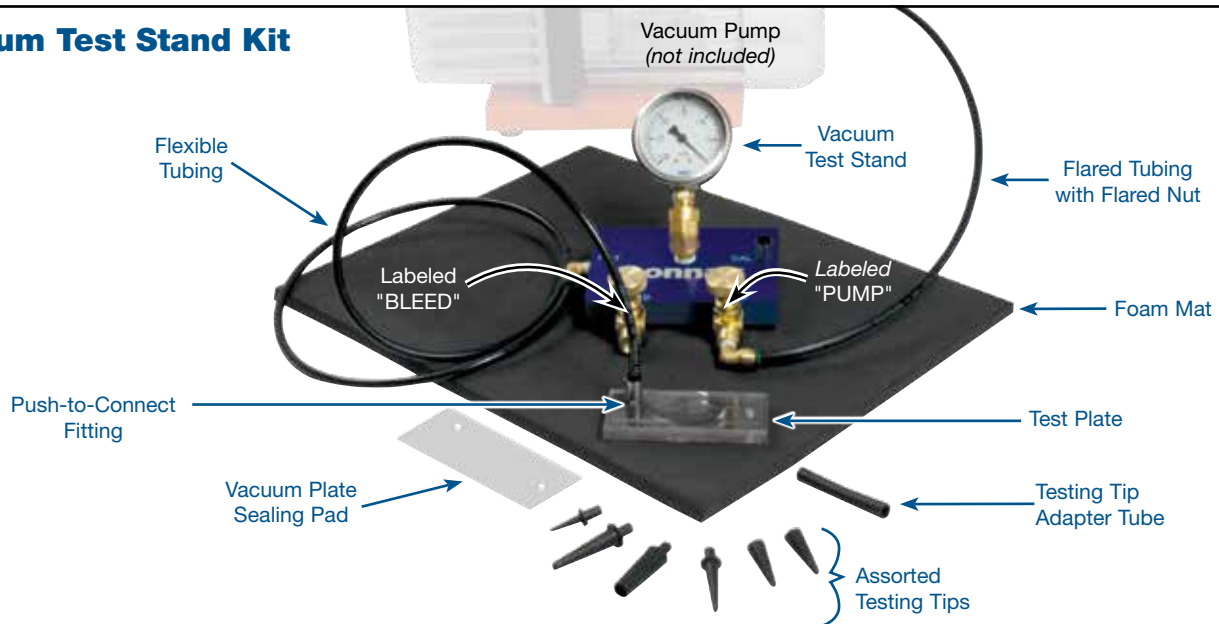

Figure 2

Critical Wear Areas & Vacuum Test Locations



Drop-In Zip Valve™
Parts Available



6L45-6L90-ZIP
Zip Kit® Available

NOTE: OE valves are shown in rest position and should be tested in rest position unless otherwise indicated. Test locations are pointed to with an arrow. Springs are not shown for visual clarity. Low vacuum reading indicates wear and Sonnax parts are noted for replacement.

NOTE: These plates do not check for wear in the pump body. Check these locations using the small test plate and sealing pad included in the VACTEST-01K.

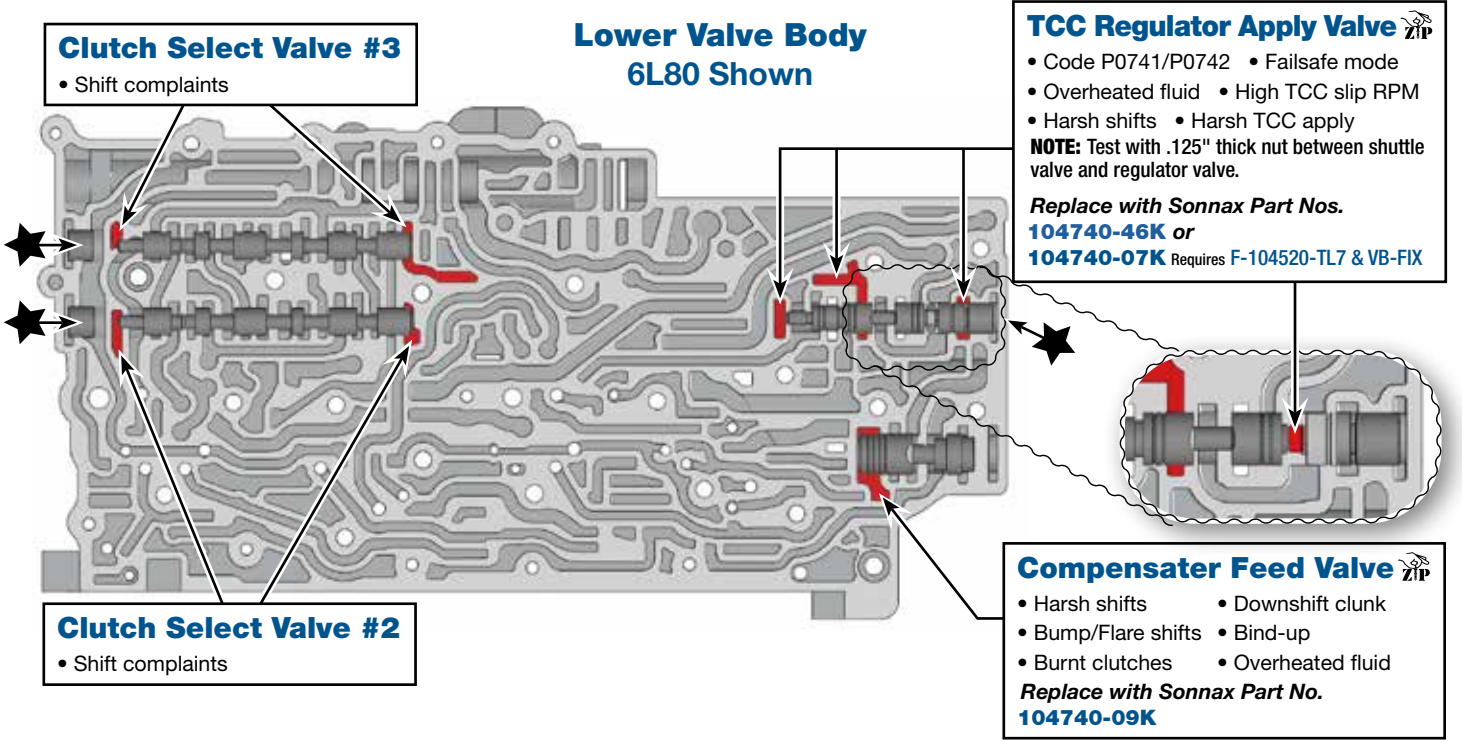
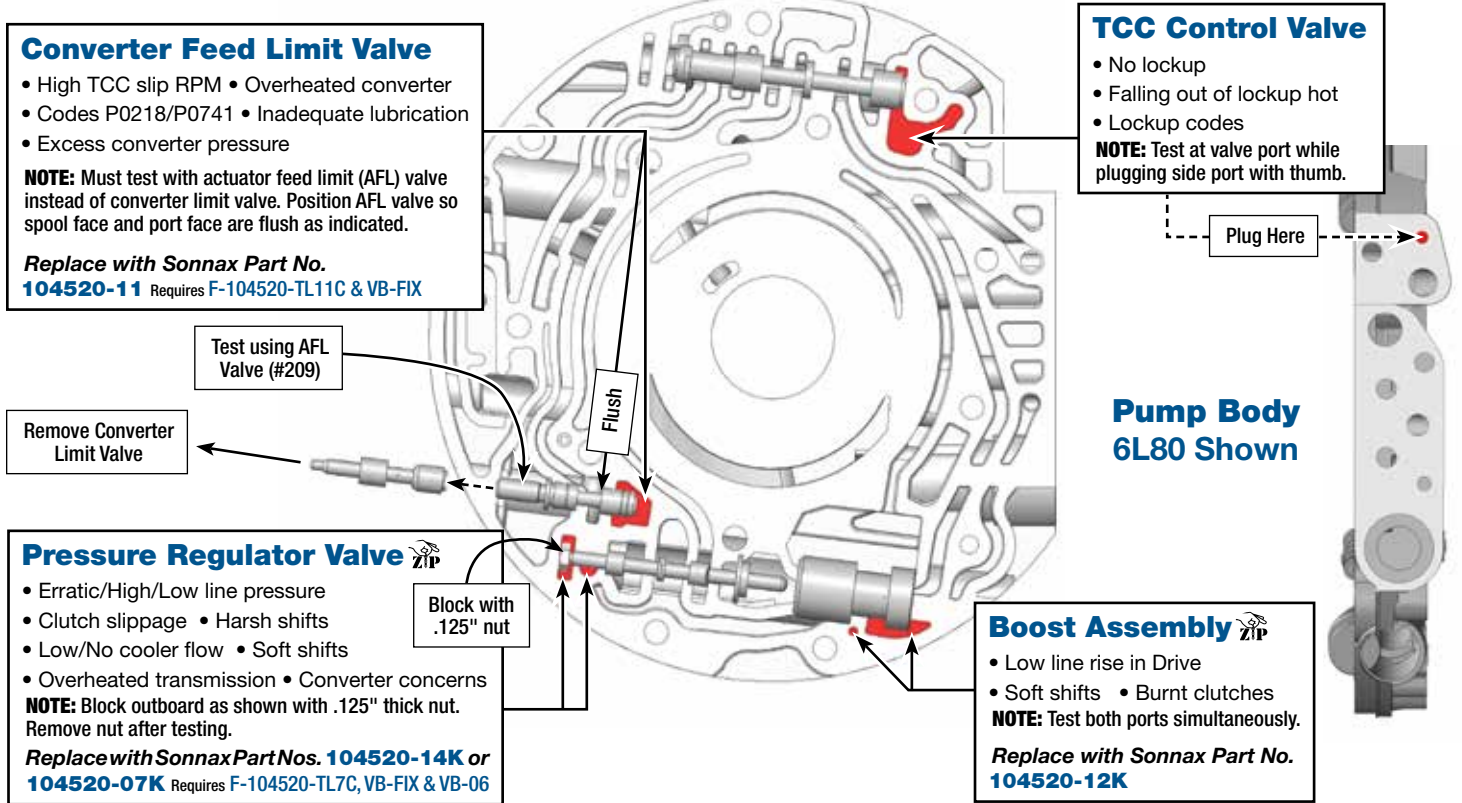



For specific vacuum test information, refer to individual part instructions included in kits and available at www.sonnax.com.

Upper Valve Body • 6L80 Shown

1-2-3-4 Clutch Regulator & Shuttle Valve

- Burnt clutches
- Shift concerns in 1st, 2nd, 3rd & 4th Gear

Test with VTP* only.

1-2-3-4 Clutch Boost Valve

- Shift quality is not load sensitive
- Burnt clutches
- Clutch pressure solenoid codes
- Delayed engagement
- Harsh/Slide shifts
- Slip codes
- Slips & flares

Replace with **Sonnax Part No. 104740-01** Requires F-104740-TL & VB-FIX

End Plugs ZIP

- Burnt clutches
 - Shift concerns
- NOTE:** Test end plugs at port between valve and end plug.

Replace with **Sonnax Part No. 104740-23K**
NOTE: Several Locations = ★

3-5 Reverse Clutch Regulator Valve

- Burnt 3-5 Reverse clutch
- Delayed/No Reverse
- 3rd & 5th Shift concerns

3-5 Clutch Boost Valve

- Shift quality is not load sensitive
- Clutch pressure solenoid codes
- Burnt clutches
- Slip codes
- Delayed engagement
- Harsh/Slide shifts
- Slips & flares

Replace with **Sonnax Part No. 104740-01**
Requires F-104740-TL & VB-FIX

4-5-6 Clutch Boost Valve

- Shift quality is not load sensitive
- Clutch pressure solenoid codes
- Burnt clutches
- Slip codes
- Delayed engagement
- Harsh/Slide shifts
- Slips & flares

Replace with **Sonnax Part No. 104740-01**
Requires F-104740-TL & VB-FIX

Actuator Feed Limit Valve ZIP

- Solenoid performance codes
- Clutch failure
- Wrong gear starts
- Harsh/Soft shifts

Replace with **Sonnax Part Nos. 104740-47K or 104740-12** Requires F-104740-TL12 & VB-FIX

2-6 Clutch Regulator & Gain Valves

- Burnt 2-6 clutch
- Shift concerns in 2nd & 6th Gear

Close hole on other side or use rubber mat.

Insets shown with end plugs removed for clarity only. Test with end plugs installed.

CBR1/4-5-6 Clutch Regulator Valve

- Burnt 4-5-6 clutch
- Shift concerns in 4th, 5th & 6th Gear

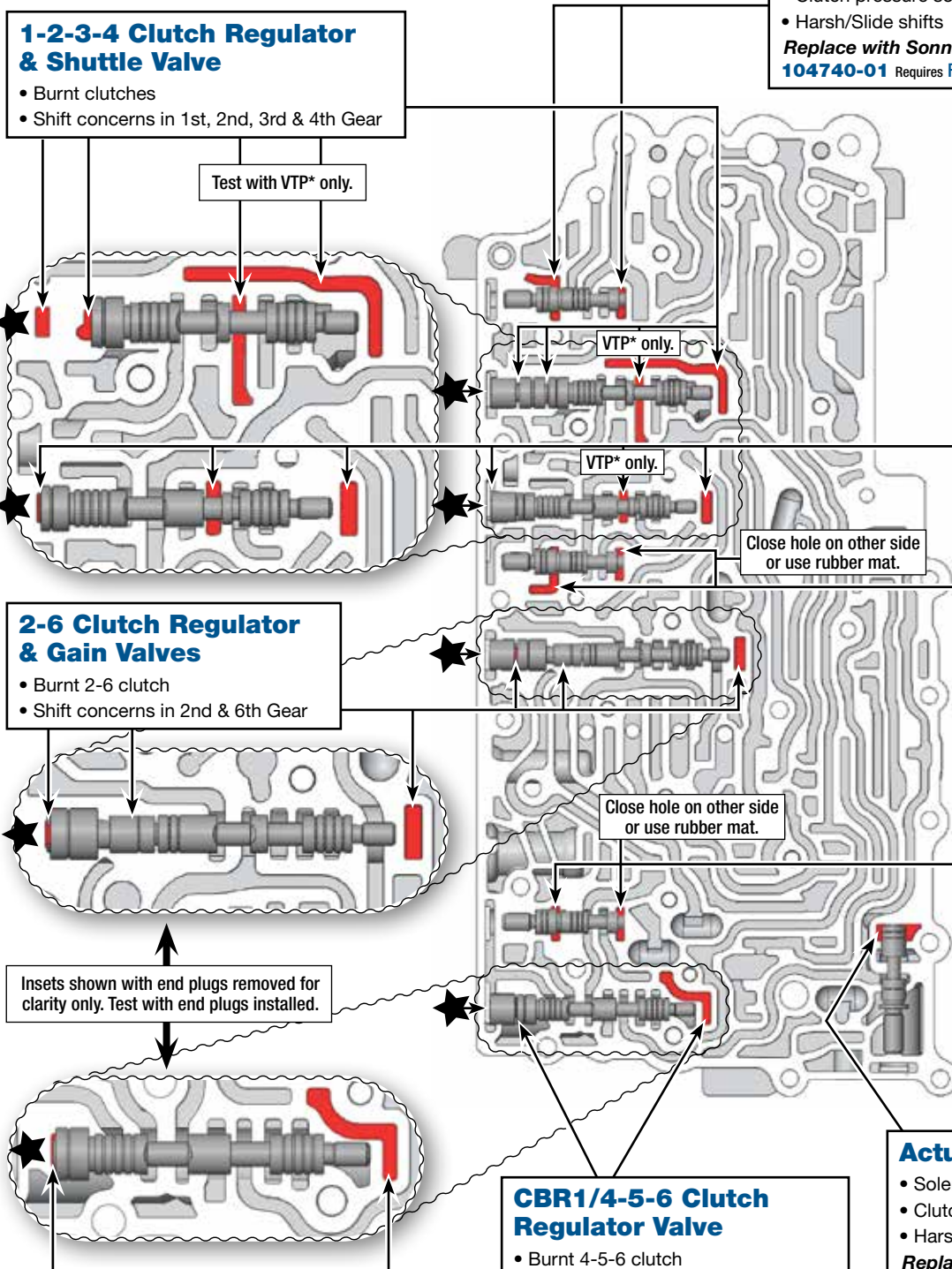

OE Exploded View

Upper Valve Body • 6L80 Shown

NOTE: Depending upon vehicle application, the OE springs shown may not be present.

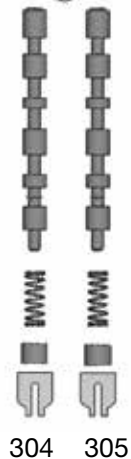
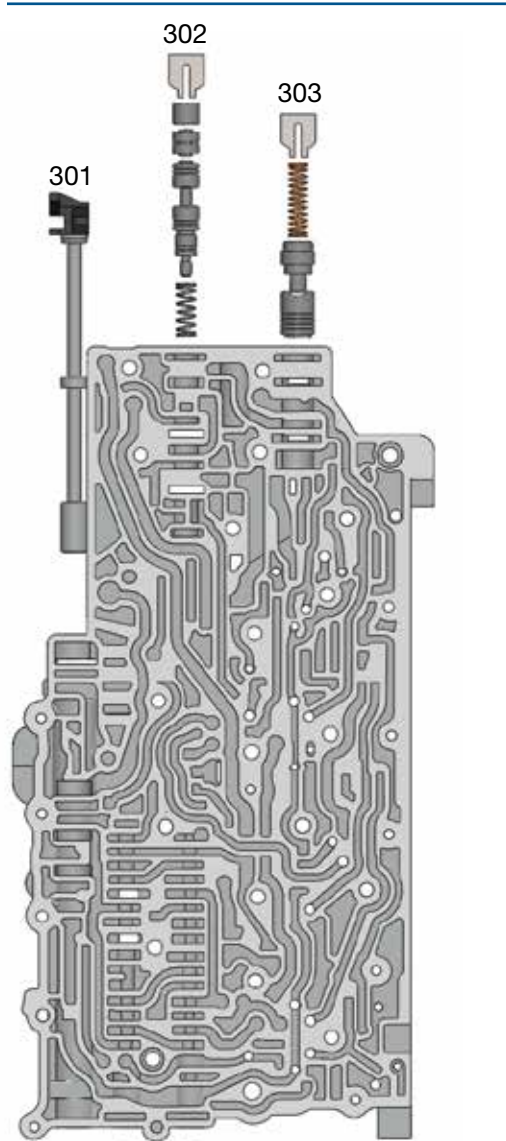

Lower Valve Body • 6L80 Shown

NOTE: Depending upon vehicle application, the OE springs shown may not be present.

Lower Valve Body Descriptions

I.D. No.	Description
301	Manual Valve
302	TCC Regulator Apply Valve
303	Compensator Feed Valve
304	Clutch Select Valve #3
305	Clutch Select Valve #2

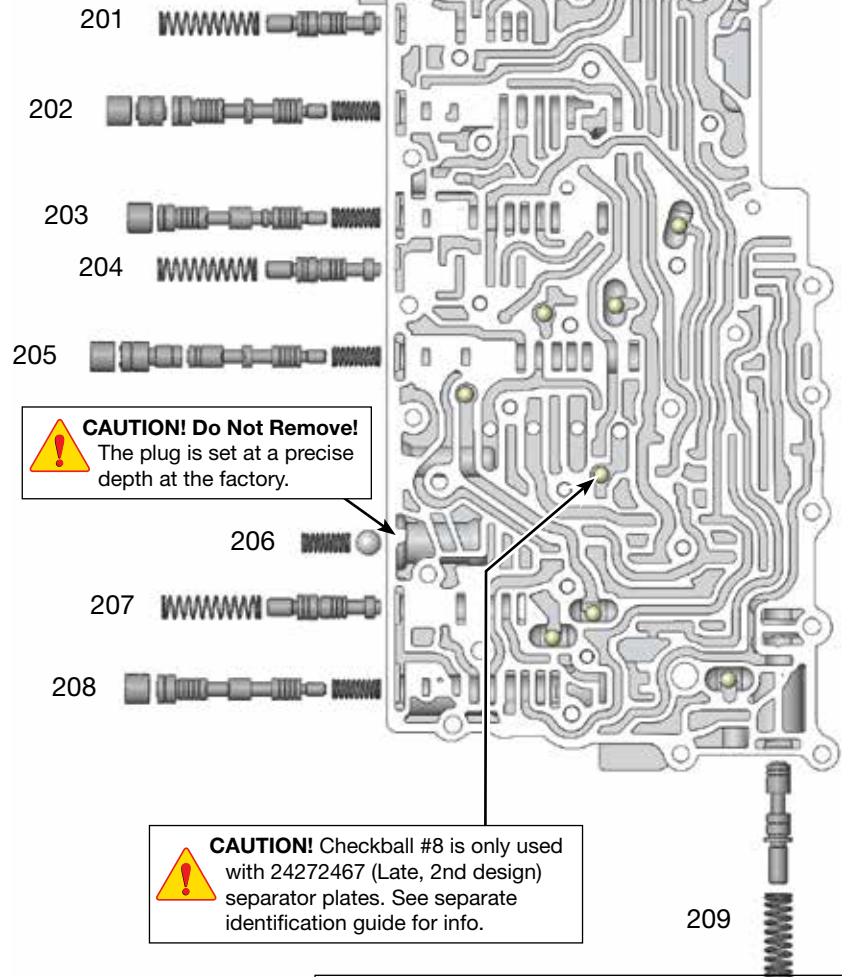

Upper Valve Body Descriptions

I.D. No.	Description
201	1234 Clutch Boost Valve
202	1234 Clutch Regulator & Shuttle Valve
203	3-5 Reverse Clutch Regulator Valve
204	3-5 Reverse Clutch Boost Valve
205	2-6 Clutch Regulator & Gain Valves
206	Exhaust Backfill Pressure Relief Valve
207	456 Clutch Boost Valve
208	CBR1/C456 Clutch Regulator Valve
209	Actuator Feed Limit Valve

Orifice Legend

Unit Stock or Tag No.

Orifice Location	Valve/Circuit Checked	Sonnax Part Number	Special Instructions	Actual Vacuum Reading	Minimum Vacuum Standard
201A	1234 Clutch Boost Valve Balance End	104740-01			
201B	1234 Clutch Boost Outboard Spool	104740-01			
202A	1234 Clutch Regulator & Shuttle Valve Inboard Spool				
202B	1234 Clutch Regulator & Shuttle Valve Center Spool				
202C	1234 Clutch Regulator & Shuttle Valve Outboard Spool				
202D	1234 Clutch Regulator & Shuttle Valve Shuttle Valve & Bore Plug	104740-23K			
203A	3-5-R Clutch Regulator Valve Inboard Spool				
203B	3-5-R Clutch Regulator Valve Between 2nd & 3rd Spool				
203C	3-5-R Clutch Regulator Valve Bore Plug	104740-23K			
204A SI	3-5-R Clutch Boost Valve Inboard Spool	104740-01	Close open casting on other side		
204B	3-5-R Clutch Boost Valve Outboard Spool	104740-01			
205A	2-6 Clutch Regulator Valve Inboard Spool				
205B	2-6 Clutch Regulator Valve Outboard Spool				
205C	2-6 Clutch Regulator Valve Bore Plug	104740-23K			
206A	Exhaust Backfill Pressure Relief Ball				
207A SI	4-5-6 Clutch Boost Valve Inboard Spool	104740-01	Close open casting on other side		
207B	4-5-6 Clutch Boost Valve Outboard Spool	104740-01			
208A	CBR1/C4-5-6 Clutch Regulator Valve Inboard Spool				
208B	CBR1/C4-5-6 Clutch Regulator Valve Outboard Spool/Bore Plug				
209A	Actuator Feed Limit Valve	104740-12			
302A	TCC Regulator Apply Valve Inboard Spool/Spring End	104740-07K			
302B	TCC Regulator Apply Valve 2nd Inboard Spool	104740-07K			
302C	TCC Regulator Apply Valve Between Outboard Spool and Plug	104740-07K			
302D	TCC Regulator Apply Valve Bore Plug	104740-07K			
303A	Compensator Feed Balance End	104740-09K			
304A	Clutch Select Valve #3 Inboard Spool/Spring End				
304B	Clutch Select Valve #3 Outboard Spool/Bore Plug	104740-23K			
305A	Clutch Select Valve #2 Inboard Spool/Spring End				
305B	Clutch Select Valve #2 Outboard Spool/Bore Plug	104740-23K			

NOTE: The TCC Control Valve, Converter Feed Limit Valve, Pressure Regulator Valve, and Boost Assembly reside in the pump body. These vacuum test plates do not check for wear in the pump body. Please reference the vacuum test locations on page 4 of this guide, and test using the small test plate and sealing pad included in the **VACTEST-01K**.