

### Solenoid Spacer & Service Kit

#### Part No.

# 44836-02K

- Solenoid Spacer
- Green O-Ring
- Blue O-Ring
- Black O-Rings (6) Small
- Brown O-Rings (6)
- Black O-Rings (6) Large
- Square-Cut Rubber Insulators (6)
- Switch Diaphragms (5)
- 62TE Line Pressure Solenoid O-Rings (2) Small & Large
- Connector Seal
- Springs (5)
- Filter Screen See Figure 10

### Chrysler 45RFE, 545RFE, 62TE, 65RFE, 66RFE, 68RFE

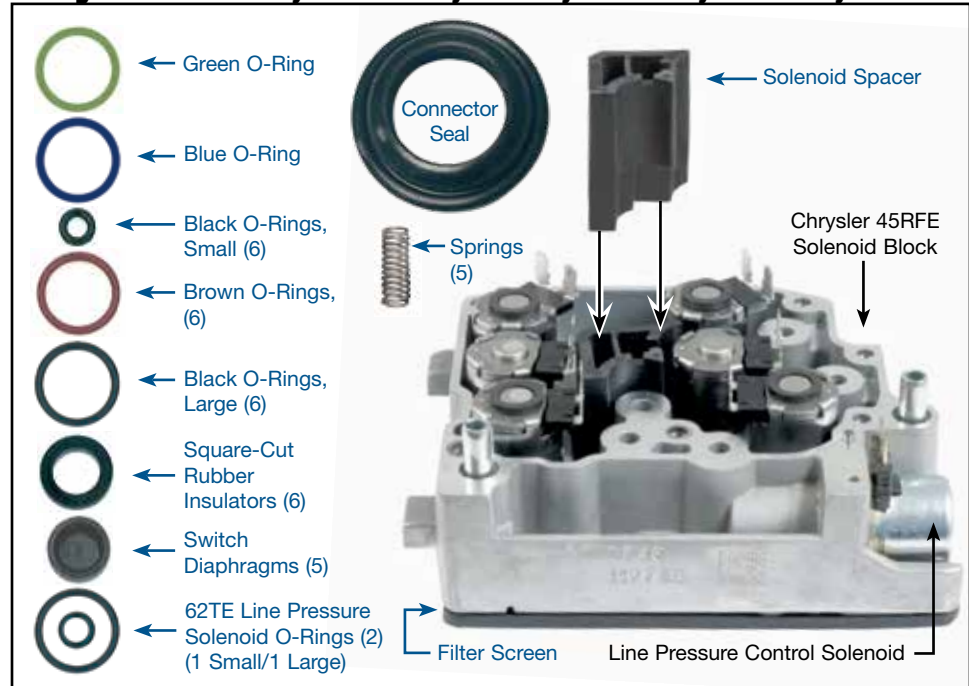

**NOTE:** This kit is designed to service all 62TE models and RFE units listed with a white solenoid connector only.

**NOTES AND CAUTIONS:** Care needs to be taken to ensure that there are no misplaced solenoids when working on these units. Chrysler uses two different solenoid designs housed inside of this solenoid assembly. These are:

- NV (Normally Vented Solenoids)
- NA (Normally Applied Solenoids)

Always note and mark the locations of all the solenoids during disassembly to ensure they are reinstalled into their original locations when servicing (**see Note under component list**).

#### 1. Disassembly

- a. Remove the solenoid screen plate from the bottom of the solenoid/switch assembly.



**NOTE:** Take care not to damage the seal between the plastic screen and the aluminum casting.

- b. Using a Torx® T20 bit, remove the seven retainer screws from the top metal spring retainer plate of the solenoid assembly. There are six long silver screws and one short black screw. Removing the plate exposes five pressure switch release springs; remove and discard springs.
- c. Remove the plastic solenoid/switch conductor plate from the top of the solenoid assembly. Take care when lifting this solenoid/switch conductor plate from the aluminum housing not to crack this fragile plastic plate. Typically the solenoids will remain in the aluminum housing during this disassembly, and it is recommended they be removed one at a time during the assembly process to ensure they are reinstalled in their proper locations.



**IMPORTANT:** Do not mix up the solenoids.

**CARE NOTE:** There are six steel torque tubes installed into the plastic plate's screw holes to prevent overtorque from the six silver retaining screws. Don't lose them, as they will need to be installed into the conductor plate for assembly.

### 1. Disassembly (continued)

- d. Remove the five pressure switch caps, diaphragms and switch pistons from the solenoid/switch conductor plate assembly.
- e. Ensure that the five brass pressure switch pistons and piston seat areas in the conductor plate are flat and clean for assembly.



**IMPORTANT:** Keep all parts clean for reassembly.

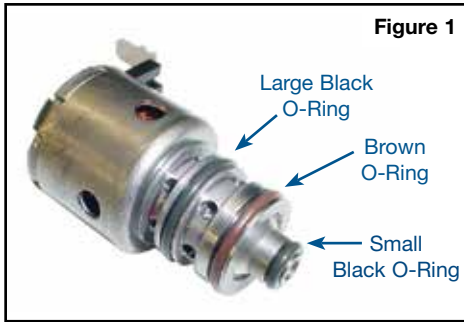

### 2. Installation & Assembly

- a. Replace the three O-rings on each of the six solenoids with O-rings. The brown O-ring will go between the two black O-rings (**Figure 1**).
- b. Using assembly gel, lube the O-rings on the solenoids for assembly. Install the six solenoids into the housing. Pay close attention that you install the NA (normally applied) solenoids in the locations marked (**Figure 2**).
- c. **All Except 62TE:** Remove line pressure solenoid (**main photo**). Replace the two line pressure solenoid O-rings using one green and one blue O-ring (**Figure 3**).  
**For 62TE:** Use black O-rings (.715" dia. and .425" dia.) for line pressure solenoid.
- d. Install the six Sonnax square-cut rubber insulators on top of each of the control solenoids and secure with assembly gel.
- e. Install the Sonnax solenoid spacer in the solenoid housing (**main photo**).



**NOTE:** If there are any burrs on the mating surfaces of the plastic spacer, make sure to sand or file flat before installation.

- f. Install the five OE brass switch pistons into the conductor plate housing with spring hole down (**Figure 4**).
- g. Install five Sonnax switch diaphragms on top of brass contacts with lip facing upward (**Figure 5**).
- h. Install the five OE steel covers over each of the switch towers and secure with assembly gel.
- i. Carefully install the OE conductor plate over the dowel pins of the housing and ensure each of the solenoid flat spade contacts are secure in position (**Figure 6**).

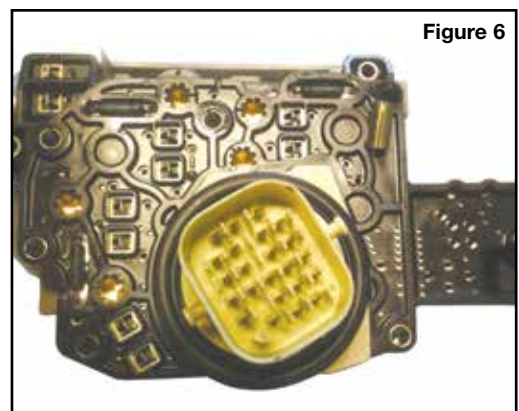
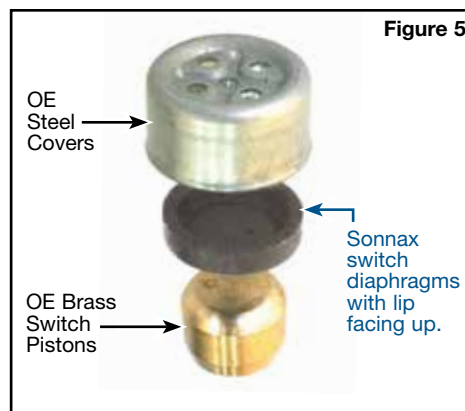
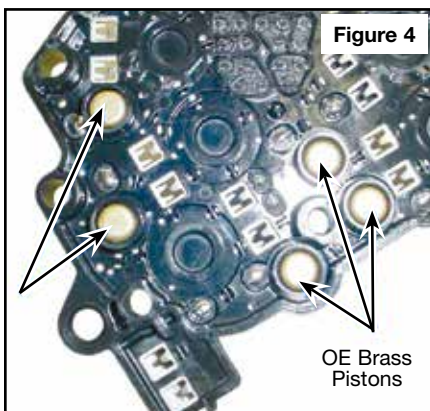
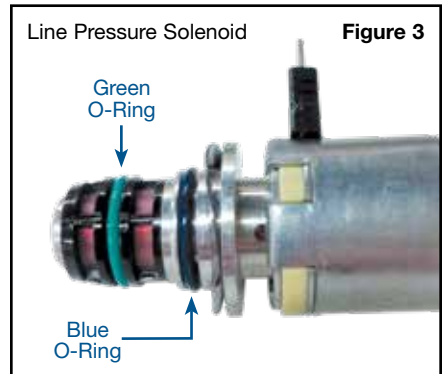
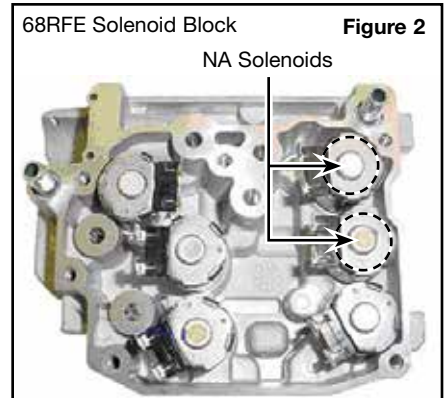

### 2. Installation & Assembly (continued)

- j. With conductor plate installed onto the solenoid housing, install one Sonnax spring into each of the five contact piston cups (**Figure 7**).
- k. Install the six OE retaining screw spacers into the plastic housing for assembly of the cover plate.
- l. Install the OE cover plate and be careful not to damage the temperature sensor at location shown (**Figure 8**).
- m. Install one black and six silver OE retaining screws and hand-tighten. Use caution to avoid stripping out the plastic with the black retaining screw. Final torque: 50 in-lb (**Figure 9**).
- n. Install Sonnax solenoid filter/screen plate to the bottom of housing (**Figure 10**).

