

GM 8L45, 8L90 TCC ZIP KIT®

PART NUMBER 8L45-8L90-TCC-ZIP

QUICK GUIDE

Parts are labeled here in order of installation. See other side of sheet for details on kit contents.

INSTALLATION DIAGRAM

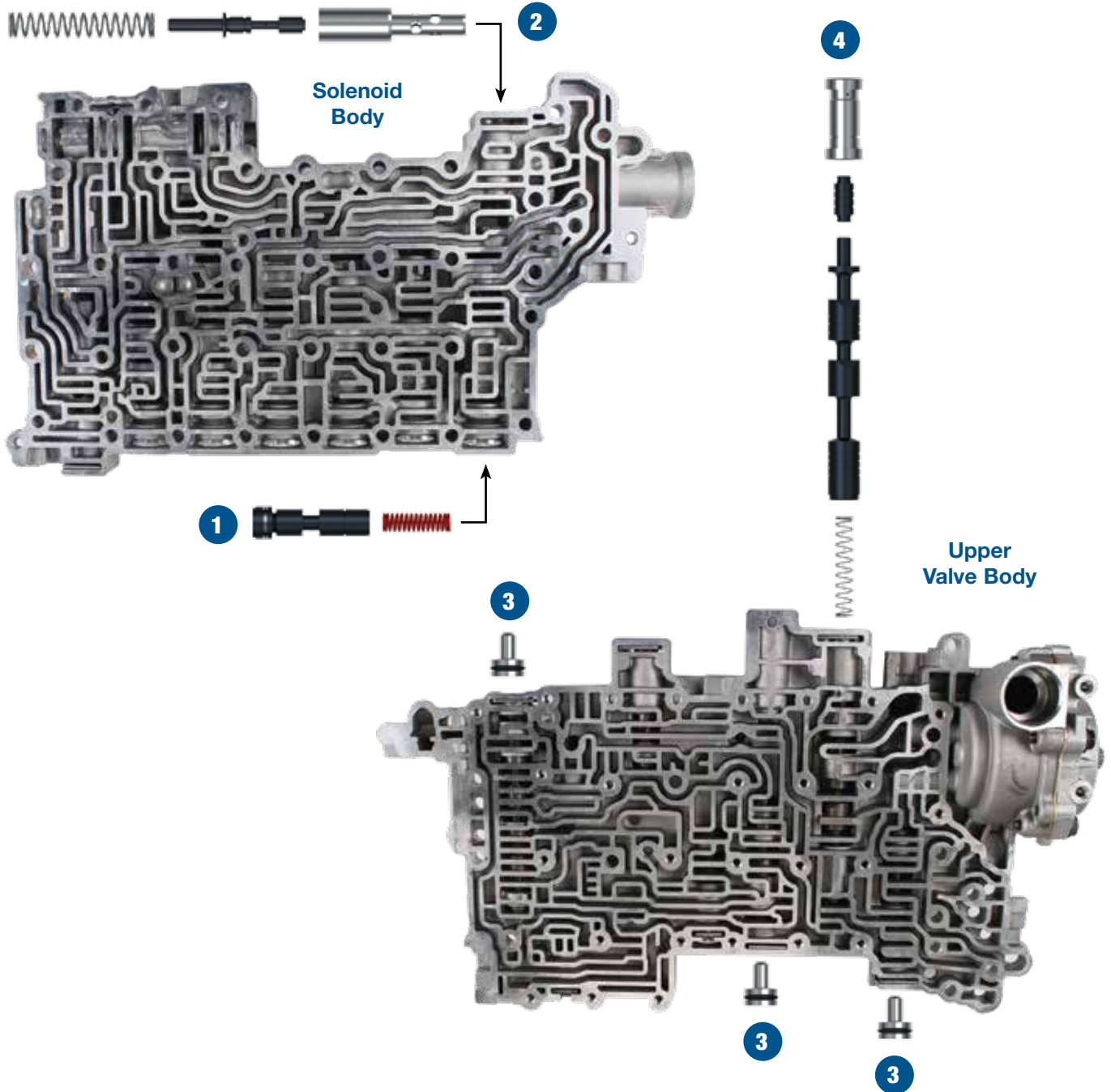

In addition to general rebuilding tips and technical information, the technical booklet included in this kit contains vacuum testing and additional repair options for higher mileage units or for repairing specific complaints which are beyond the scope of this kit.

Kit Contents & Installation Steps

NOTE: Reference Installation & Testing Booklet for details on how to vacuum test the bores for wear.

Step 1 Replace TCC Control Valve

Place scarf-cut-seal into shallow groove on valve. Install spring into valve spring pocket.

Packaging Pocket 1

- Valve
- Spring, Red
- Seal

Recommended: Vacuum Test Tool 154740-TL11

Optional: Bore Sizing Tool 154740-BST11

Step 2 Replace Converter Feed Limit Valve

Install Sonnax sleeve and valve into bore as shown. Install Sonnax spring into the bore and onto valve stem. Reinstall OE retaining clip.

Packaging Pocket 2

- Valve
- Sleeve
- Spring

Step 3 Replace End Plugs

Install O-ring in the plug groove. Coat O-ring and end plug with Sonnax Slippery Stick **O-LUBE** and roll on bench to size. Install O-ringed end plugs in proper bores, noting proper orientation. Reinstall OE retainers.

Packaging Pocket 3

- End Plugs (3)
- O-Rings (4) 1 Extra



NOTE: The default override valve end plug must be installed with the end plug protrusion outboard toward OE retainer, the other two locations require the end plug protrusion to face inboard.

Step 4 Replace Pressure Regulator & Shuttle Valve/Sleeve

Insert Sonnax spring into spring pocket of Sonnax pressure regulator valve and slide into bore spring end first. Install Sonnax shuttle valve and sleeve into bore, open end of sleeve first. Reinstall OE retainer clip to secure components in the bore.

Packaging Pocket 4

- Shuttle Sleeve
- Shuttle Valve
- Spring
- Pressure Regulator Valve

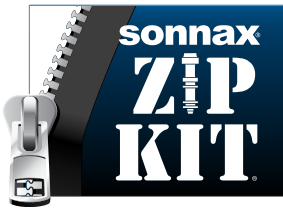

GM 8L45, 8L90 TCC ZIP KIT®

PART NUMBER 8L45-8L90-TCC-ZIP

INSTALLATION & TESTING BOOKLET



Solenoid Identification and Strategy

Clearly mark each solenoid to indicate what bore it is in before removing! The 8L45 and 8L90 use solenoid and valve body PUNs (part unique numbers, **Figures 1 & 2**) and TUN (transmission unique part number) for performance and shift strategy. The TUN is located on a tag on the side of the transmission case. The solenoid PUNs are individually programmed to the valve body PUN and transmission TUN in the TCM. If the solenoids are not placed back into the original bore, shift results will occur. Reference OEM information on when and how to reprogram if necessary.

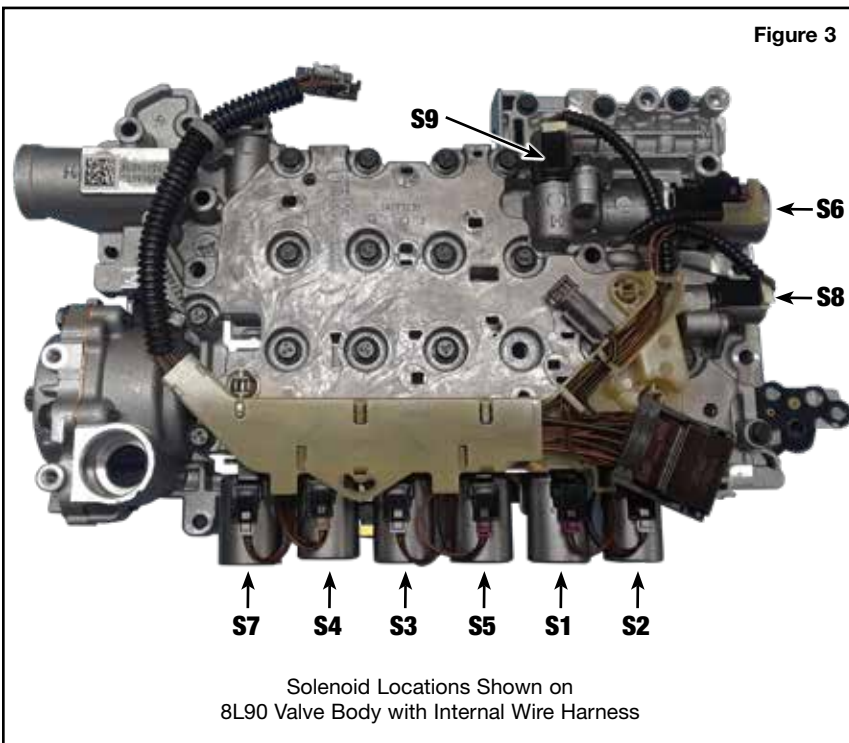
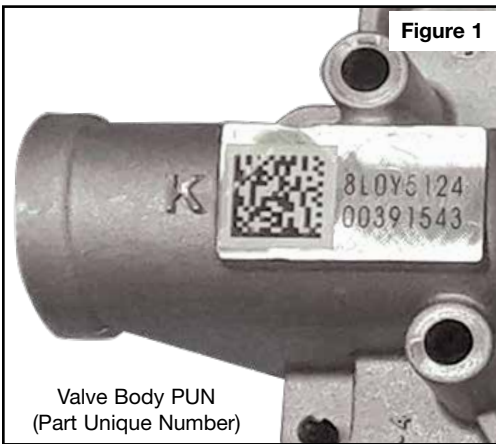

Solenoid Location & Apply Charts

Reference **Figures 3, 4, 5** and **6** for solenoid location, function, resistance and connector wire information.

Figure 4

Solenoid Number	Description	Resistance
S1	1-2-7-8 Reverse Control	4.5-5.5 Ohms
S2	1-2-3-4-5 Reverse Control	4.5-5.5 Ohms
S3	1-3-5-6-7 Control	4.5-5.5 Ohms
S4	2-3-4-6-8 Control	4.5-5.5 Ohms
S5	4-5-6-7-8 Reverse Control	4.5-5.5 Ohms
S6	Line Pressure Control	4.5-5.5 Ohms
S7	TCC Control	4.5-5.5 Ohms
S8	Default Control	11-13 Ohms
S9	1-2-3-4-5 Reverse Boost Control	11-13 Ohms

Figure 5

Terminal Number	Solenoid Number	Wire Colors	Internal Connector Color
1	S9	Green/White	Green/White
3	S7	Gray/Brown	Gray
4	S6	Gray/Green	Purple
5	S1	Brown	Purple
6	S2	Blue	Gray
7	S8	Yellow/Brown	White
10	S3	Gray	Gray
13	S4	White	Clear
14	S5	Blue/White	Purple

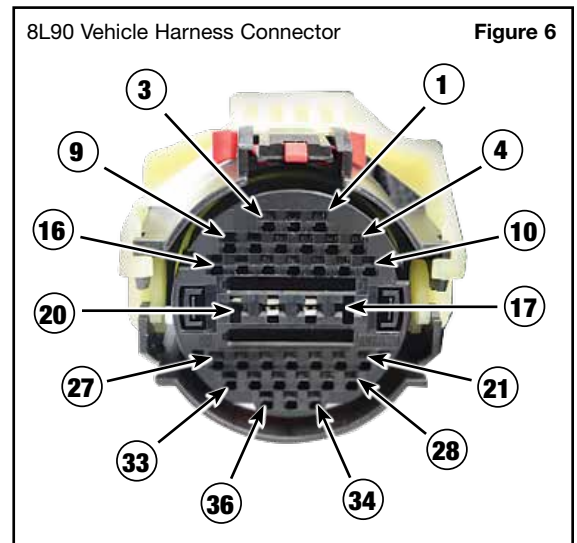

Solenoid Applications										Figure 7
Range	Gear	1-2-7-8 Reverse Clutch S1 or E N.H. Duty%/PSI	1-2-3-4-5 Reverse Clutch S2 or F N.H. Duty%/PSI	1-3-5-6-7 Clutch S3 or C N.L. Duty%/PSI	2-3-4-6-8 Clutch S4 or B N.H. Duty%/PSI	4-5-6-7-8 Reverse Clutch Sol. S5 or D N.H. Duty%/PSI	Line Press. Control S6 or J N.H. Duty%/PSI	Torque Converter Clutch Control S7 or A N.L.	Default Control S8 or G On/Off	1-2-3-4-5 Reverse Boost Sol. 9 or H On/Off
Park	P	Low/High	Low/High	Low/Low	High/Low	High/Low	Varies	OFF	OFF	OFF
Reverse	R	Low/High	Low/High	Low/Low	High/Low	Low/High	Varies	OFF	OFF	OFF
Neutral	N	Low/High	Low/High	Low/Low	High/Low	High/Low	Varies	OFF	OFF	OFF
Drive	1st	Low/High	Low/High	High/High	High/Low	High/Low	Varies	ON*	OFF / ON	OFF
	2nd	Low/High	Low/High	Low/Low	Low/High	High/Low	Varies	ON*	ON / OFF	OFF
	3rd	High/Low	Low/High	High/High	Low/High	High/Low	Varies	ON*	OFF	OFF
	4th	High/Low	Low/High	Low/Low	Low/High	Low/High	Varies	ON*	OFF	OFF
	5th	High/Low	Low/High	High/High	High/Low	Low/High	Varies	ON*	OFF	OFF
	6th	High/Low	High/Low	High/High	Low/High	Low/High	Varies	ON*	OFF	ON
	7th	Low/High	High/Low	High/High	High/Low	Low/High	Varies	ON*	OFF	ON
	8th	Low/High	High/Low	Low/Low	Low/High	Low/High	Varies	ON*	OFF	ON

Notes: **Varies** = Varies based on engine load; **ON*** = Torque Converter Clutch can be applied in 1st through 8th gears dependant on load and computer strategy;
Solenoid ID & Location = Example: S7 solenoid is the TCC solenoid and it is located in the solenoid bore marked with an A as shown in Figure 10.
 N.H. solenoid information refers to the output circuit on the solenoid. A Normally High solenoid will have high output pressure to the valve it controls at low duty % and low pressure at high duty %.
 N.L. Solenoid will have low output pressure at low Duty % and high output pressure at high duty%.

Transmission Service Fast Learn Procedure

This should be completed after valve body and/or transmission service to avoid drive-ability complaints.

1. If a solenoid, TCM or transmission assembly was replaced, reference OEM material and perform the solenoid valve characterization reprogramming.
2. With ignition ON, clear any DTCs with scan tool.
3. Turn ignition and all vehicle systems OFF.
4. Temperature needs to be between 167° –185°F.
5. With engine running, transmission in drive position and brake applied, use a scan tool to perform the fast learn procedure. Follow scan tool instructions.
6. Ignition OFF for 2 minutes.
7. Once the fast learn has been successfully reset, drive the vehicle at light acceleration up to 65 mph, then come down to a stop. Repeat this a minimum 10 times.

Component Application Chart								Figure 8	
Range	Gear	1-3-5-6-7 Clutch	4-5-6-7-8 Reverse Clutch	2-3-4-6-8 Clutch	1-2-7-8 Reverse Clutch	1-2-3-4-5 Reverse Clutch	Torque Converter Clutch	8L45 Gear Ratio	8L90 Gear Ratio
Park	P				X*	X*			
Reverse	R		X		X	X		3.93	3.82
Neutral	N				X*	X*			
Drive	1st	X			X	X	X**	4.62	4.56
	2nd			X	X	X	X**	3.04	2.97
	3rd	X		X		X	X**	2.07	2.08
	4th		X	X		X	X**	1.66	1.69
	5th	X	X			X	X**	1.26	1.27
	6th	X	X	X			X**	1.00	1.00
	7th	X	X			X	X**	.85	.84
	8th		X	X	X		X**	.66	.65

* Applied with no output load.
 ** The converter clutch can be applied from 1st thru 8th gears depending on shift conditions.

Transmission Fluid

The 8L90 transmission uses Mobil 1 Synthetic LV ATF HP or GM #19417577.

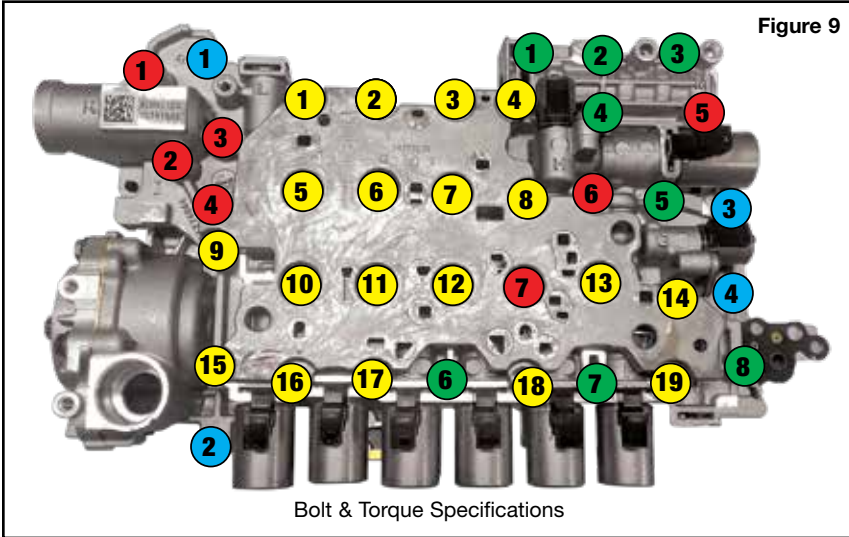

No. Bolts	Bolt Color Code	Bolt Head
19	Yellow	8mm
8	Green	10mm

NOTE: Torque all bolts at 71 in-lb or 8 Nm.

No. Bolts	Valve Body-to-Case Retaining Bolts	Bolt Head
7	Red	8mm
4	Blue	10mm

NOTE: Torque all bolts at 80 in-lb or 9 Nm.

NOTE: Bolt for detent spring torque to 106 in-lb or 12 Nm.

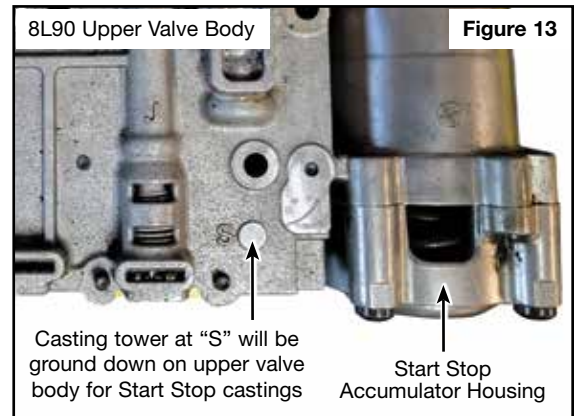
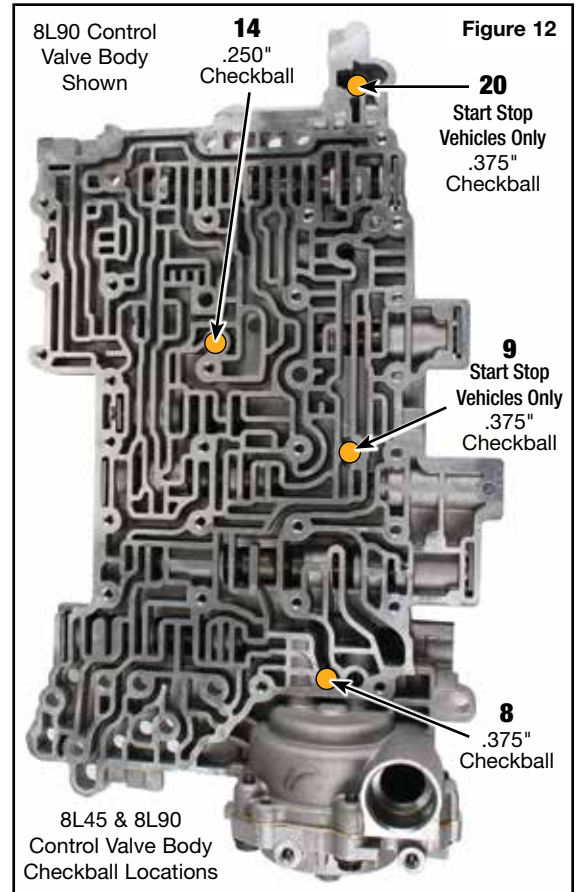
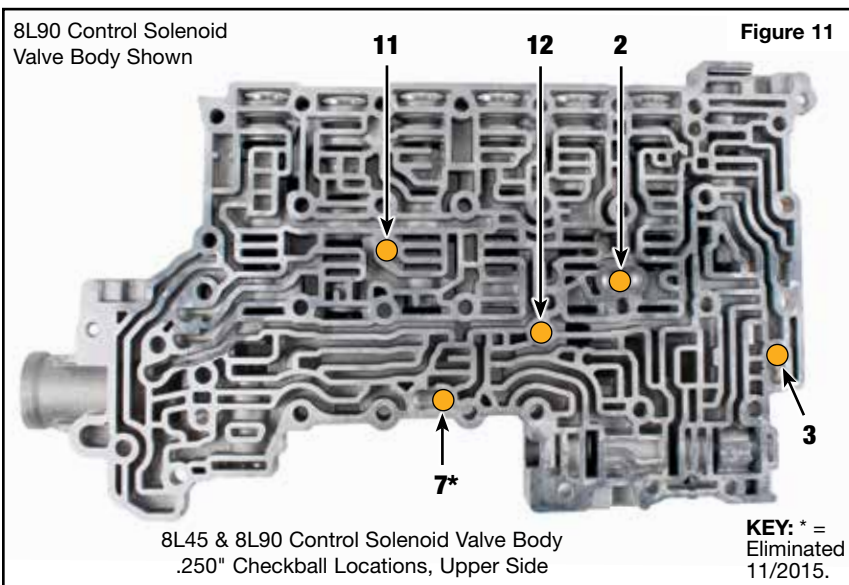
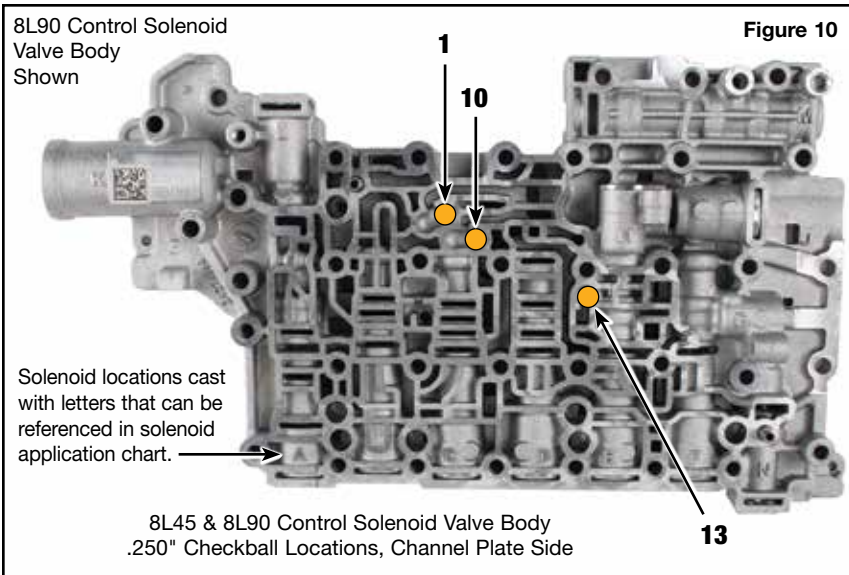

Critical Wear Areas & Vacuum Test Locations



Drop-In Zip Valve™
Parts Available

NOTE: OE valves are shown in rest position and should be tested in rest position unless otherwise indicated. Test locations are pointed to with an arrow. Springs are not shown for visual clarity. Low vacuum reading indicates wear and Sonnax parts are noted for replacement.

Upper Valve Body • 8L90 Shown



For specific vacuum test information, refer to individual part instructions included in kits and available at www.sonnax.com.

**Lube Override Enable Valve (8L45)
1-2-3-4-5 Reverse Clutch
Boost Valve (8L90)**

- No Reverse
- Reverse slip
- Forward motion in Neutral
- No Forward
- No 6th

Default Override Valve

- No Reverse
- Reverse slip

TCC Fault Valve

- TCC apply & release concerns

Lube Flow Regulator Valve

- Overheating & reduced lube feed
- Overheated transmission & converter

TCC Control Valve

- No converter apply
- Converter shudder & TCC slip
- Overheated converter
- TCC apply & release concerns

Actuator Feed Limit Valve

- Harsh shifts
- Soft slide shifts
- No shift
- Burnt clutches

Pressure Regulator Valve ZIP

- Low line pressure
- Burnt clutches
- Harsh shifts
- Low cooler flow
- Loss of lube oil
- Overheated transmission & converter
- High line pressure

Replace with Sonnax Part Nos.
154740-02K** or
154740-29K O-Ringed

Pressure Regulator Shuttle Valve ZIP

- High line pressure
- Harsh shifts
- Low cooler flow
- Loss of lube oil
- Overheated transmission & converter

Replace with Sonnax Part Nos.
154740-09K or
154740-30K O-Ringed

O-Ringed End Plugs ZIP

- Gear ratio & solenoid codes
- Lube failures
- Poor lube oil control

Replace with Sonnax Part No.
154740-17K**

★ = Several Locations

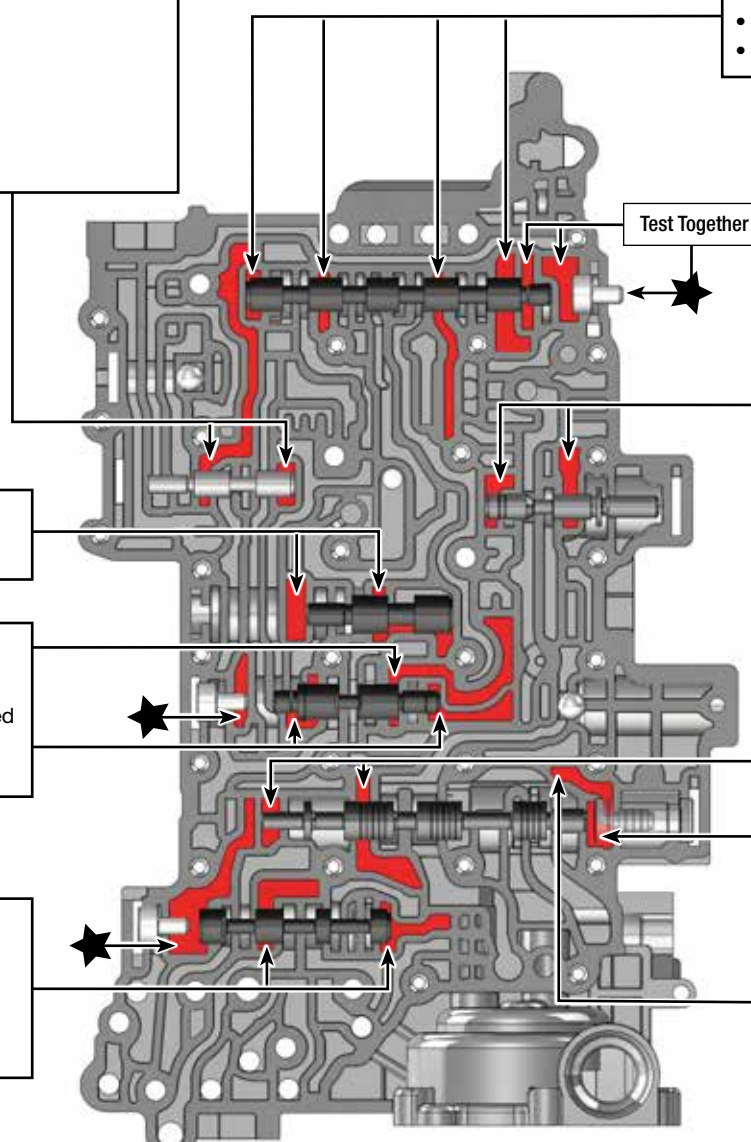

NOTE: Part numbers with an asterisk (*) are included in Shift Zip Kit 8L45-8L90-SHIFT-ZIP.

Part numbers with two asterisks (**) are included in TCC Zip Kit 8L45-8L90-TCC-ZIP.

Critical Wear Areas & Vacuum Test Locations



NOTE: OE valves are shown in rest position and should be tested in rest position unless otherwise indicated. Test locations are pointed to with an arrow. Springs are not shown for visual clarity. Low vacuum reading indicates wear and Sonnax parts are noted for replacement.

Control Solenoid Body • 8L90 Front Shown

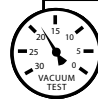

For specific vacuum test information, refer to individual part instructions included in kits and available at www.sonnax.com.

1-2-3-4-5 Reverse Low Control Valve

- Burnt clutches • Pressure loss
- Poor shift quality • Burnt converter
- TCC apply & release concerns

Replace with Sonnax Part No. **154740-11K****

154740-TL11 Recommends Vacuum Test Tool
154740-BST11 Recommends Bore Sizing Tool

1-2-7-8 Reverse Control Valve

- Burnt clutches • Pressure loss
- Poor shift quality

Replace with Sonnax Part No. **154740-13K***

154740-TL11 Recommends Vacuum Test Tool
154740-BST13 Recommends Bore Sizing Tool

4-5-6-7-8 Reverse Control Valve

- Burnt clutches • Pressure loss
- Poor shift quality

Replace with Sonnax Part No. **154740-13K***

154740-TL11 Recommends Vacuum Test Tool
154740-BST13 Recommends Bore Sizing Tool

1-3-5-6-7 Control Valve

- Burnt clutches • Pressure loss
- Poor shift quality • Burnt converter
- TCC apply & release concerns

Replace with Sonnax Part No. **154740-11K****

154740-TL11 Recommends Vacuum Test Tool
154740-BST11 Recommends Bore Sizing Tool

2-3-4-6-8 Control Valve (S4)

- No converter apply
- Converter shudder & TCC slip
- Overheated converter

Replace with Sonnax Part Nos. **154740-11K*** 2018–Earlier or **154740-24K** 2019–Later or **154740-26K**** 2019–Later, Oversized

154740-TL11 *Recommends Vacuum Test Tool
154740-BST11 *Recommends Bore Sizing Tool
F-154740-TL26 & VB-FIX **Requires Tool Kits

Lube Regulator Valve (8L45)

1-2-3-4-5 Reverse Clutch Boost Valve (8L90)

- 5-6 Bind-up • Burnt clutches

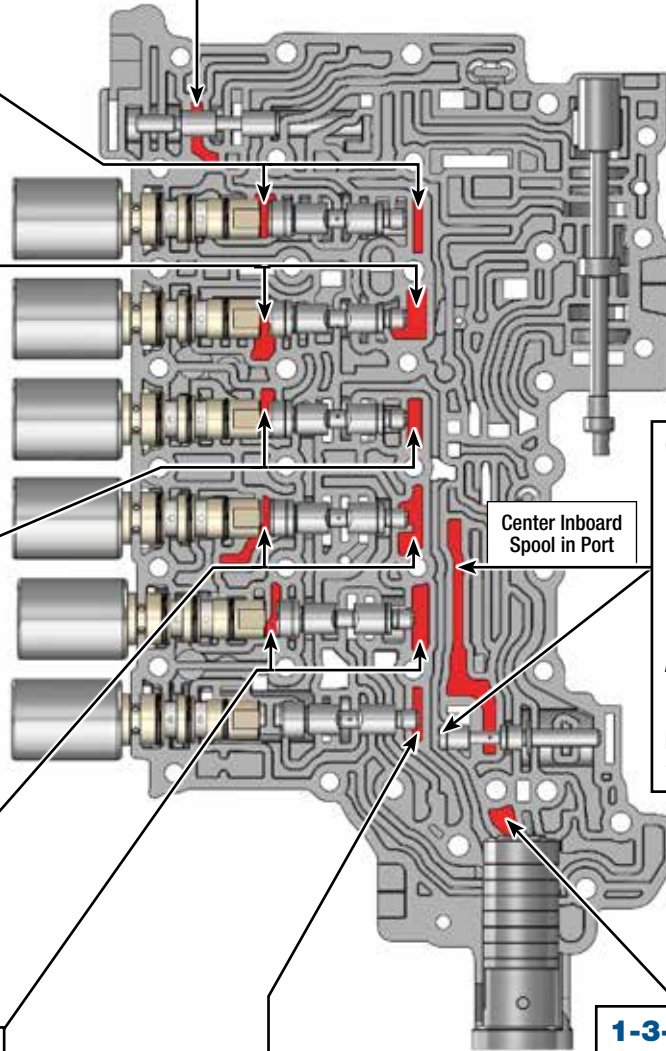

Center Inboard Spool in Port

Converter Feed Limit Valve

- Codes P0218, P0741
- Overheated converter
- Inadequate lubrication
- Excess converter pressure
- High TCC slip RPM

Replace with Sonnax Part Nos. **154740-19K**** or **154740-22K**

F-154740-TL22 & VB-FIX *Requires
154740-TL22 Recommends Vacuum Test Tool

1-3-5-6-7 Accumulator Piston

- Clutch slippage
- Burnt clutches
- Flare shifts
- Ratio codes

Replace with Sonnax Part No. **154740-15K***

TCC Control Valve

- No converter apply
- Converter shudder & TCC slip
- Overheated converter

Replace with Sonnax Part No. **154740-11K****

154740-TL11 Recommends Vacuum Test Tool
154740-BST11 Recommends Bore Sizing Tool

Part numbers with an asterisk () are included in this Zip Kit.

Critical Wear Areas & Vacuum Test Locations



Drop-In Zip Valve™
Parts Available

NOTE: OE valves are shown in rest position and should be tested in rest position unless otherwise indicated. Test locations are pointed to with an arrow. Springs are not shown for visual clarity. Low vacuum reading indicates wear and Sonnax parts are noted for replacement.

Control Solenoid Body • 8L90 Back Shown



For specific vacuum test information, refer to individual part instructions included in kits and available at www.sonnax.com.

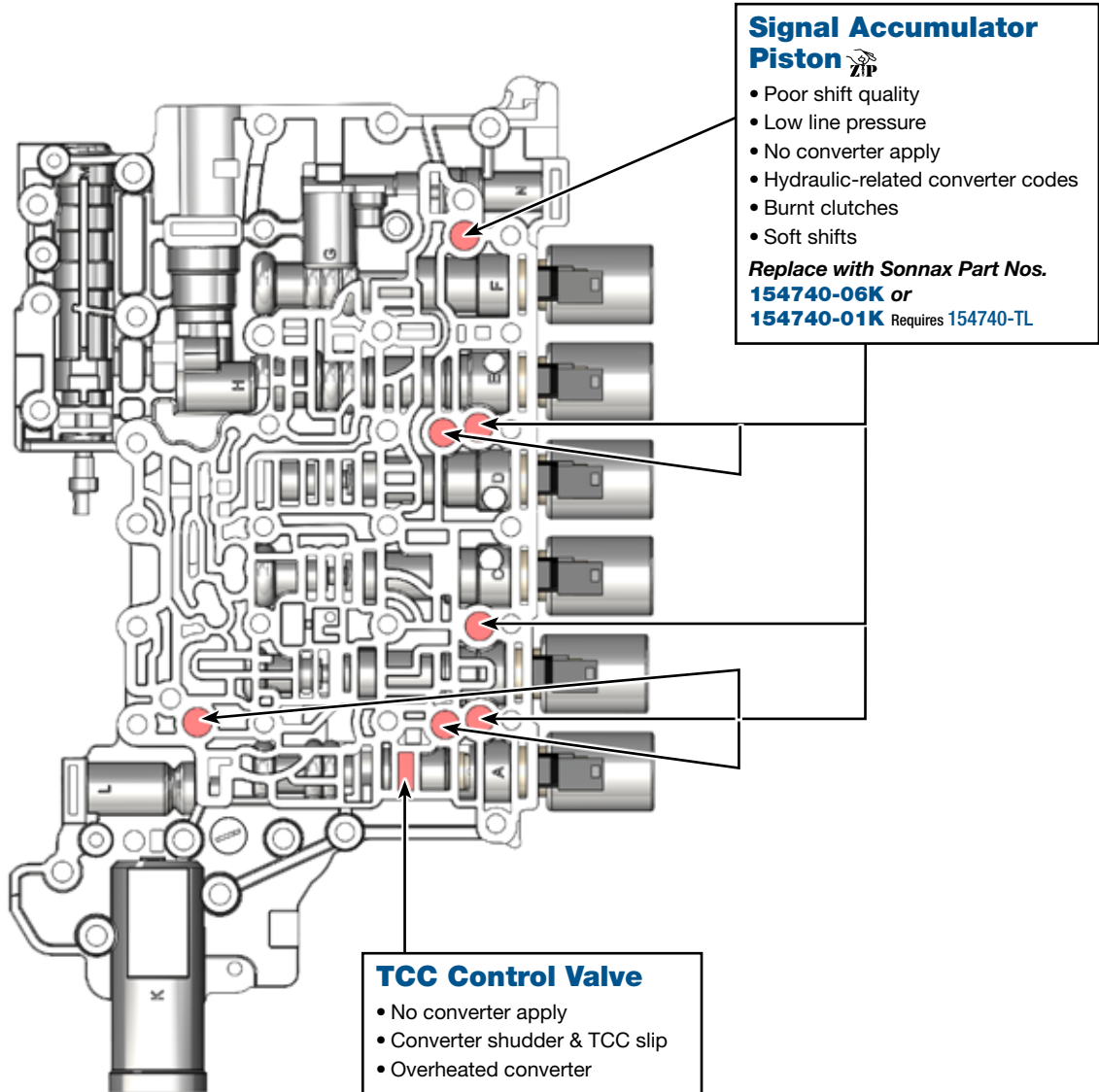

Part numbers with an asterisk () are included in this Zip Kit.

OE Exploded View

Upper Valve Body • 8L90 Shown

NOTE: Depending on vehicle application, the OE springs shown may not be present.

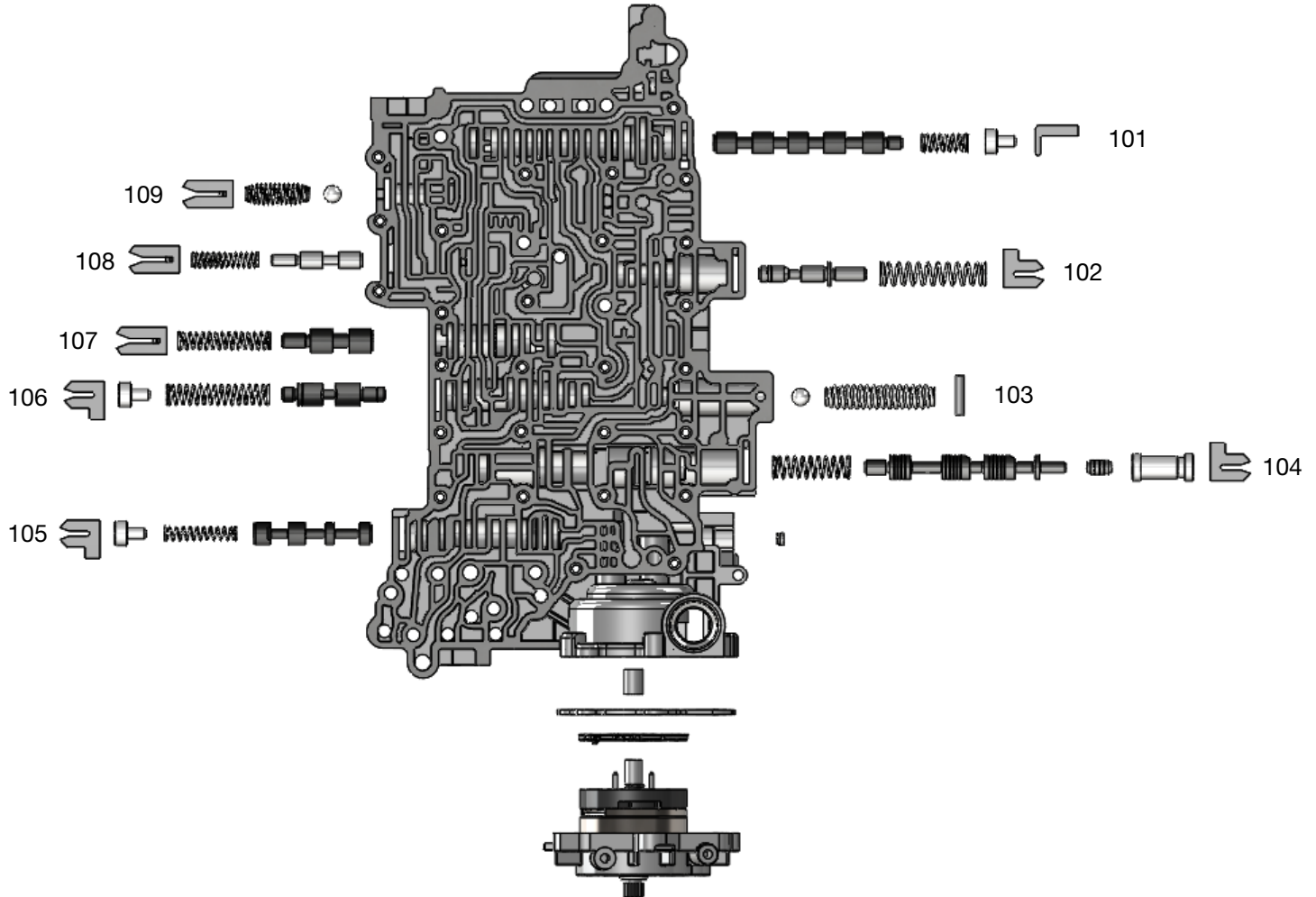

Upper Valve Body 8L45 & 8L90 Descriptions

I.D. No.	Description
101	Default Override Valve
102	Actuator Feed Limit Valve
103	Line Pressure Blowoff Ball Valve
104	Pressure Regulator Valve (Inboard) & Shuttle Valve (Outboard)
105	TCC Control Valve
106	Lube Flow Regulator Valve
107	TCC Fault Valve
108	Lube Override Enable Valve (8L45), 1-2-3-4-5 Reverse Clutch Boost Valve (8L90)
109	Clutch Piston Exhaust Blowoff Ball Valve

OE Exploded View

Control Solenoid Body • 8L90 Shown

NOTE: Depending upon vehicle application, the OE springs shown may not be present.

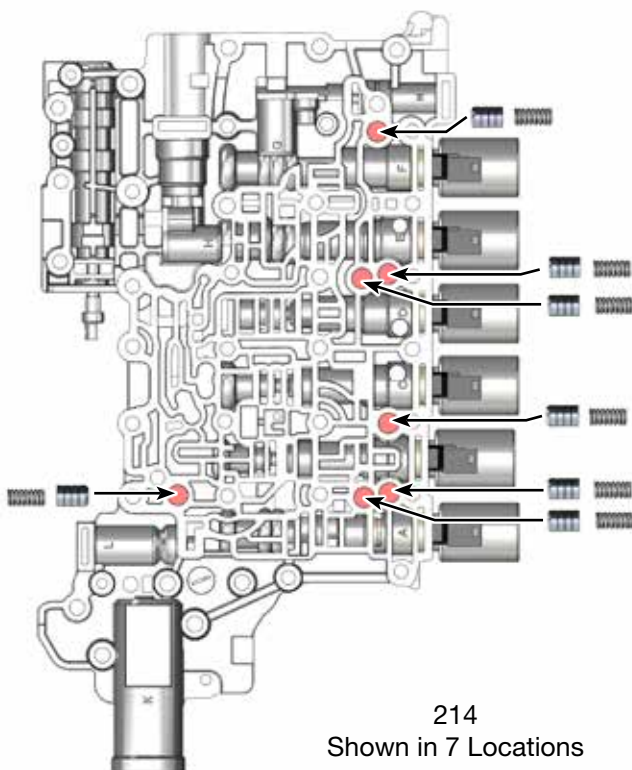
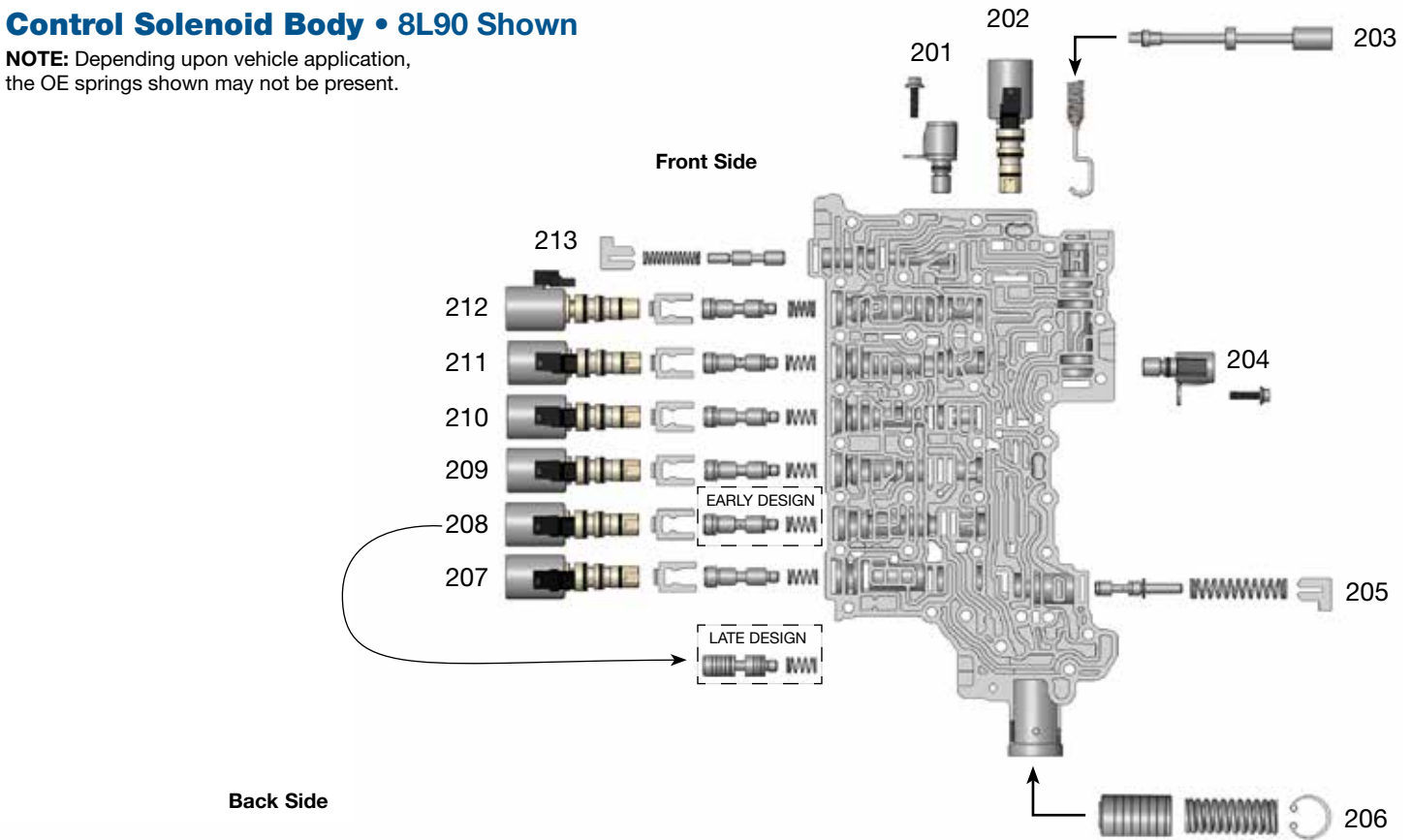

Control Solenoid Valve Body 8L45 & 8L90 Descriptions	
I.D. No.	Description
201	Default Control Solenoid
202	Line Pressure Control Solenoid
203	Manual Valve
204	1-2-3-4-5 Reverse Boost Solenoid
205	Converter Feed Limit Valve
206	1-3-5-6-7 Accumulator Piston
207	TCC Control Solenoid & Valve
208	2-3-4-6-8 Control Solenoid & Valve
209	1-3-5-6-7 Control Solenoid & Valve
210	4-5-6-7-8 Reverse Control Solenoid & Valve
211	1-2-7-8 Reverse Control Solenoid & Valve
212	1-2-3-4-5 Reverse Low Control Solenoid & Valve
213	Lube Regulator Valve (8L45), 1-2-3-4-5 Reverse Clutch Boost Valve (8L90)
214	Signal Accumulator Piston