



CHRYSLER 948TE; HONDA/ACURA, 9-SPEED; ZF9HP48 ZIP KIT®

PART NUMBER 948TE-ZF9-HONDA-ZIP

IDENTIFICATION GUIDE

IDENTIFY CASTINGS

PBW (Park By Wire)

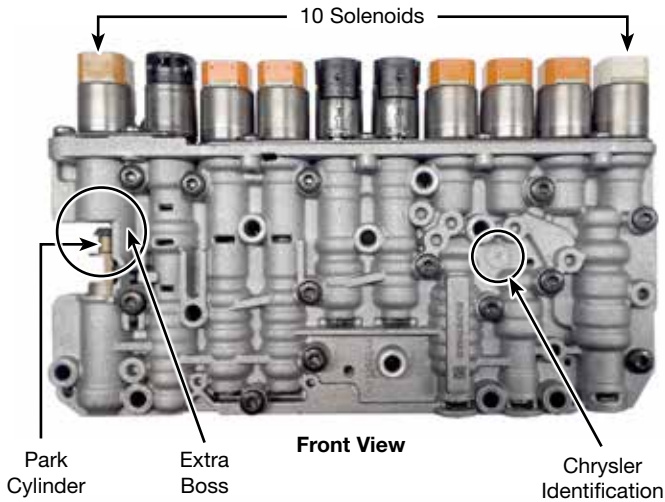

PBC (Park By Cable)

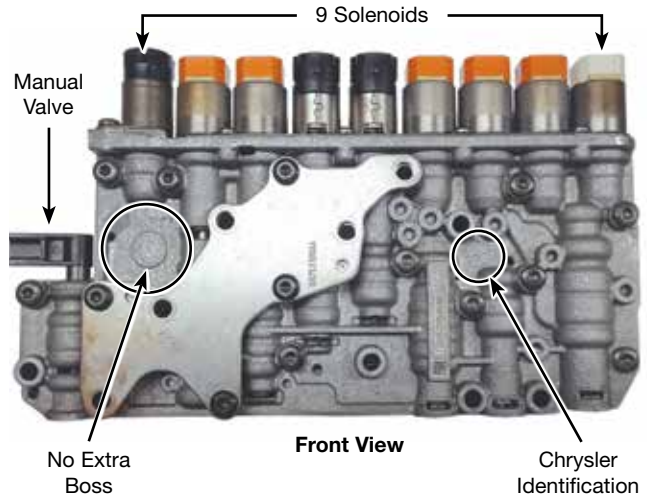

PBW (Park By Wire)

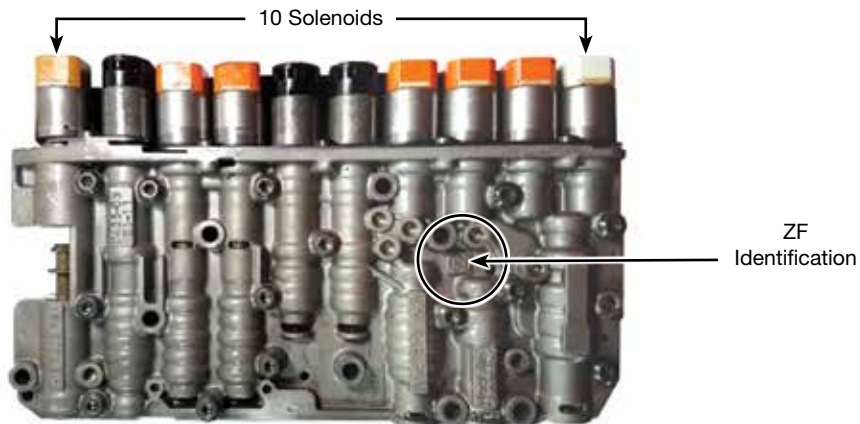

Valve body Identification

There are two variations of the 948TE valve body. The main differences are how the Park position is selected.

Park By Wire (PBW)

The first variation is referred to as Park By Wire. This type has full electronic control. There is an external cable that connects to the Park release lever, but it is only used for emergency use or for towing. There is an emergency pull inside the vehicle that releases the parking pawl manually when this cable is engaged.

Park By Cable (PBC)

The second variation is referred to as Park By Cable. This type utilizes a cable to move the manual valve, from the driver, input to engage or disengage the parking pawl.

The simplest way to ID them is to count the solenoids, note the PBW has 10 and the PBC has 9. The pictures also show differences in the manual valve and the cover that is used in the PBC.

The PBW and PBC valve bodies are not interchangeable as the solenoid configuration is different as well as the internal components and small parts.

The Honda applications use the ZF9HP48 PBW design.

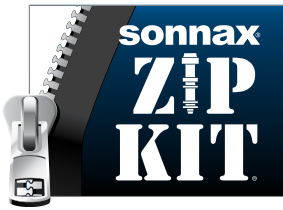

CHRYSLER 948TE; HONDA/ACURA, 9-SPEED; ZF9HP48 ZIP KIT®

PART NUMBER 948TE-ZF9-HONDA-ZIP

QUICK GUIDE

Parts are labeled here in order of installation. See other side of sheet for details on kit contents.

INSTALLATION DIAGRAM

ZF9HP48 PBW
Inner Valve Body



- 1
- 1
- 1

NOTE: These two locations are not applicable to the PBC Inner Valve Body.

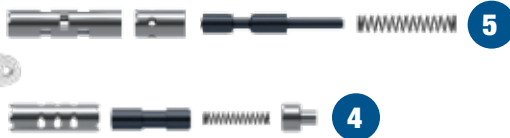

ZF9HP48 PBC
Inner Valve Body

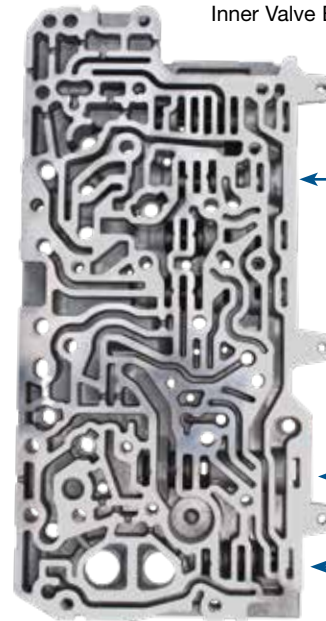

- 1
- 5
- 4

ZF9HP48 PBW
Outer Valve Body



- 3
- 3
- 2
- 2

- 1

ZF9HP48 PBC
Outer Valve Body

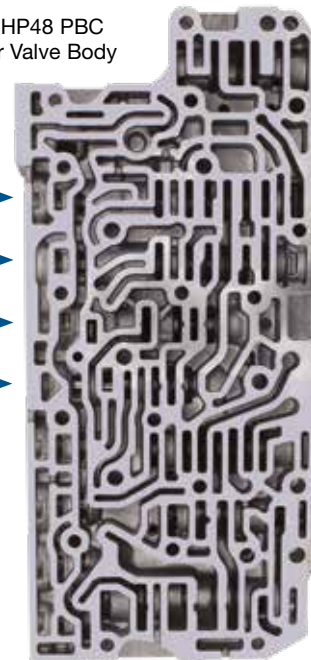

- 3
- 3
- 2
- 2

- 1

In addition to general rebuilding tips and technical information, the technical booklet included in this kit contains vacuum testing and additional repair options for higher mileage units or for repairing specific complaints which are beyond the scope of this kit.

Kit Contents & Installation Steps

Step 1 Replace OE End Plugs

PBW: Three in inner valve body and one in outer valve body.
PBC: One in inner valve body and one in outer valve body.

Place O-rings into shallow groove on end plugs. Lubricate with Sonnax slippery stick **O-LUBE**. Roll on bench to size. Install end plugs with small stem outboard.

NOTE: Two are not required with the PBC style valve body.

Packaging Pocket 1

- End Plugs (4)
- O-Rings (6) 2 Extra

Step 2 Replace Internal OE End Plugs

PBW: Two in outer valve body.
PBC: Two in outer valve body.

Place O-rings into shallow grooves on end plugs. Lubricate with Sonnax slippery stick **O-LUBE**. Roll on bench to size. For installation or removal ease, install with threaded end outboard.

Packaging Pocket 2

- End Plugs (2)
- O-Rings (6) 2 Extra

Step 3 Replace OE A & F Dog Clutch Sleeve & Plunger Valve

PBW: Two in outer valve body.
PBC: Two in outer valve body.

Install plunger valve into dog clutch sleeve and install the assembly into bore.



CAUTION! Fits units with .227" dia. plunger valve only. Do not use if original plunger dia. measures .196".

Packaging Pocket 3

- Sleeves (2)
- Valves (2)

Step 4 Replace OE Shift Valve System Pressure Valve Lineup

PBW: One in inner valve body.
PBC: One in inner valve body.

Remove and discard all OE bore components except the retainer. Insert Sonnax sleeve fully into bore with rounded end face slots facing outboard. Install Sonnax valve into sleeve with spring pocket facing outboard. Install Sonnax spring and endplug. Secure with OE retainer.

Packaging Pocket 4

- Sleeve
- Valve
- Spring
- End Plug

Step 5a Block Solenoid Pressure Regulator Balance Port

Drill indicated separator plate orifice with included .062" dia. drill bit. Remove any burrs. If using straight plug, insert into orifice and peen on both sides of plate. If using optional small rivet, insert into orifice and using wire cutters, snip the stem end of the rivet if/as necessary to provide for a small head once peened in place. Peen the rivet in place on head side of plate also. After peening on both sides of the plate, ensure plate will still sit flush on mating cast surfaces.

Packaging Pocket 5

- Drill Bit .062" dia. (Not Shown)
- Aluminum Plug .062" dia. (Not Shown)
- Rivet (Not Shown)

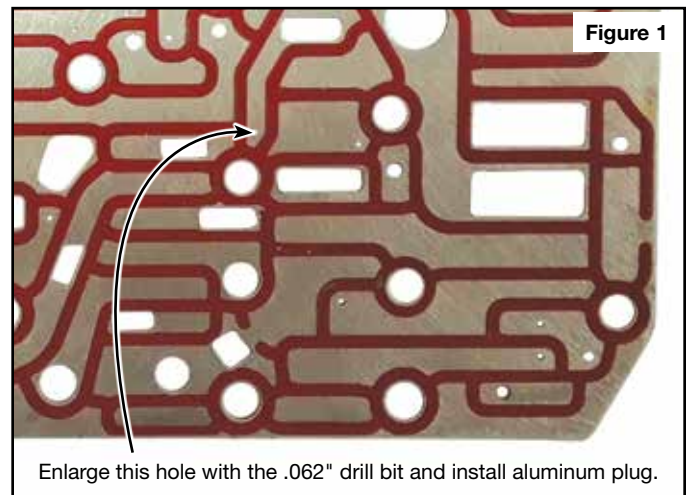

Step 5b Replace OE Solenoid Pressure Regulator Valve Lineup

PBW: One in outer valve body.
PBC: One in outer valve body.

Remove and discard all OE bore components except retainer and end plug. Insert Sonnax sleeve/valve assembly into bore. Sleeve should be installed with open end outboard. Valve should be installed with spring stem outboard. Insert sleeve extension into bore with chamfer and lube hole end inboard. Insert spring over valve spring stem. Reinstall OE end plug and retainer.

NOTE: In some instances it may be necessary to remove a small amount of material from the end of the sleeve extension to ensure proper fit when installing OE end plug and retainer.

Packaging Pocket 6

- Sleeve
- Sleeve Extension
- Valve
- Spring

The parts listed here may be protected by patent number 8,919,381.

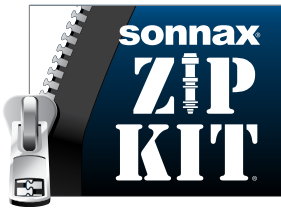

CHRYSLER 948TE; HONDA/ACURA, 9-SPEED; ZF9HP48 ZIP KIT®

PART NUMBER 948TE-ZF9-HONDA-ZIP

INSTALLATION & TESTING BOOKLET

Technical Tips

Reprogramming

Many transmission drivability complaints related to harsh shifts and downshift clunks have been addressed with software updates. It is highly recommended to check and verify the latest software is installed in the PCM/TCM. Refer to OE reflashing procedure for further information.

Solenoid Identification

PBC and PBW solenoid configurations are different (Figure 1 & 2). The system pressure solenoid on both valve bodies is normally high and has a white cap. The clutch pack control solenoids are normally low and have orange caps.

NOTE: These white and orange cap solenoids have the same snouts and can be installed in the wrong locations. The Dog Clutch Control solenoids are on-off solenoids. The Park Control solenoid PBW and Limp Home solenoid PBC are on-off solenoids. The Park Mechanical solenoid PBW is an on-off solenoid.

Transmission Fluid

- The transmission fluid must be checked only when temperatures are between 37°C (99°F) and 45°C (113°F). See fluid check location (Figure 3).
- Fill transmission with Mopar ZF 8 and fluid. Dry fill is 6.5L.
- After filling, drive the vehicle as follows:
 - Apply the brakes.
 - Shift the transmission from Park to Reverse and Reverse to Drive 4- 5 times. Check the fluid level at the location shown or with Miller tool 10323A. See factory fill information for use.
 - Disable stop-start function.
 - Drive the vehicle up to minimum 45 mph then back to a stop 4-to-5 times. This way all gear changes can be achieved.
 - Connect the scan tool and select quick learn procedure and follow the screen prompts to relearn and reset the clutch adaptive tables.
 - Refer to OE service bulletin 21-013-16-REVB for further instructions of quick learn and adaptive reset additional information.

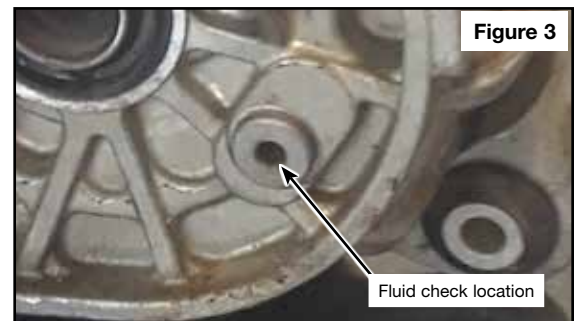
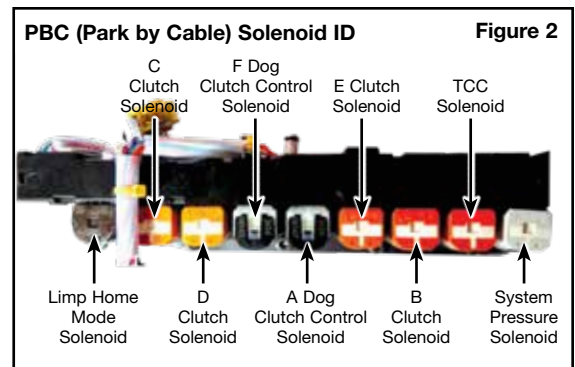
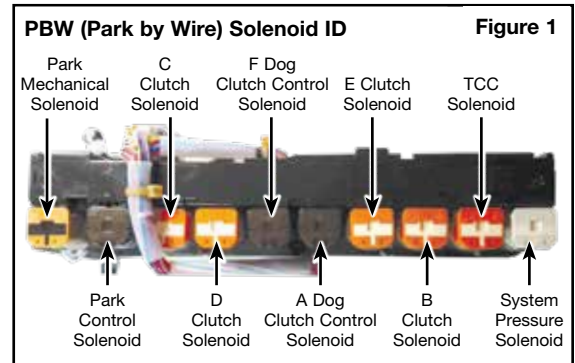

Clutch Application Chart Figure 4

Gear	A Dog	B	C Brake	D Brake	E	F Dog	Ratio
P/N				X		X	
Rev.		X		X		X	3.805:1
1	X			X		X	4.700:1
2	X		X			X	2.824:1
3	X	X				X	1.909:1
4	X				X	X	1.382:1
5	X	X			X		1:1
6	X		X		X		0.808:1
7	X			X	X		0.699:1
8			X	X	X		0.580:1
9		X		X	X		0.479:1
Limp*					X		

*Limp Home (4th Gear) default gear used on Park-By-Cable systems only.

Solenoid Apply Chart Figure 5

Gear	A Dog	B Sol.	C Sol.	D Sol.	E Sol.	F Dog
Park						
Reverse		X				X
Neutral						X
1st Gear	X					X
2nd Gear	X		X			X
3rd Gear	X	X				X
4th Gear	X				X	X
5th Gear	X	X			X	
6th Gear	X		X		X	
7th Gear	X			X	X	
8th Gear			X	X	X	
9th Gear		X		X	X	

Figure 6

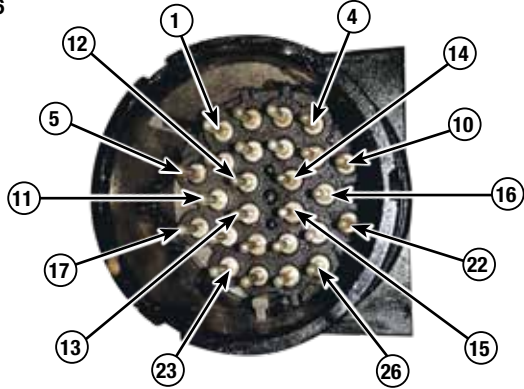

Solenoid	Terminals	Ohm Valve
B Clutch Solenoid	4 & 3	5-6 ohms
C Clutch Solenoid	4 & 5	5-6 ohms
D Clutch Solenoid	4 & 6	5-6 ohms
E Clutch Solenoid	4 & 7	5-6 ohms
A Dog Solenoid	1 & 2	10-12 ohms
F Dog Solenoid	1 & 8	10-12 ohms
Pressure Control Solenoid	1 & 9	5-6 ohms
TCC Solenoid	1 & 10	5-6 ohms
Limp Home Mode (PBC) Hydraulic Park Solenoid (PBW)	1 & 11	10-12 ohms
Mechanical Park Solenoid (PBW)	1 & 12	24-26 ohms

Figure 7

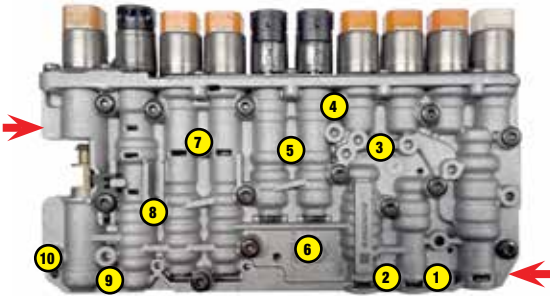

Remove 10 valve body-to-case bolts from case using Torx 40.

Zip Kit Instructions

NOTE: Valve lineups and names differ between PBW and PBC. See exploded views on page 9 & 10 for more info.

1. Valve Body Removal from Case

- Remove 10 valve body-to-case bolts with Torx® T40 (Figure 7).
- Gently pry valve body from case at two points shown with red arrows (Figure 7).

NOTE: There are numerous feed tubes which connect the valve body to the case passages that are snug.
- Once the valve body is free from the case, set it aside so the wiring harness can be removed from internal case components.
- Remove the 27 Torx bolt retaining the input and output speed sensors. Remove the 27 Torx bolt retaining the range sensor. Once these bolts are removed, the harness and valve body can then be completely removed from the case (Figure 8).

2. Valve Body Disassembly

- Remove 27 Torx bolts shown with the blue arrows. Remove the tan connector shown from the dog clutch pressure sensor. Once these items are removed, gently lift the harness up away from the solenoids. Gently pry all eight (A-H) of the feed tubes from the valve body and set aside for reuse (Figure 9 & 10).

NOTE: Some of the feed tubes may be in the case.

Figure 8

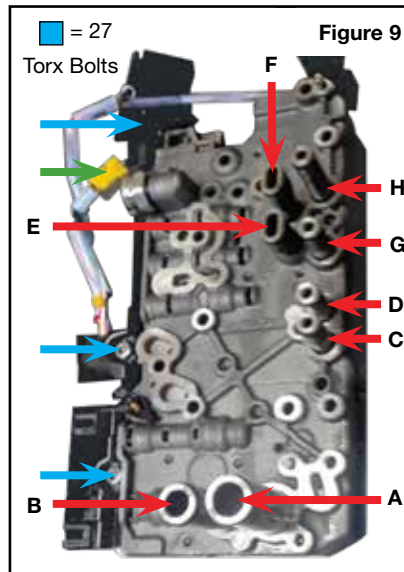
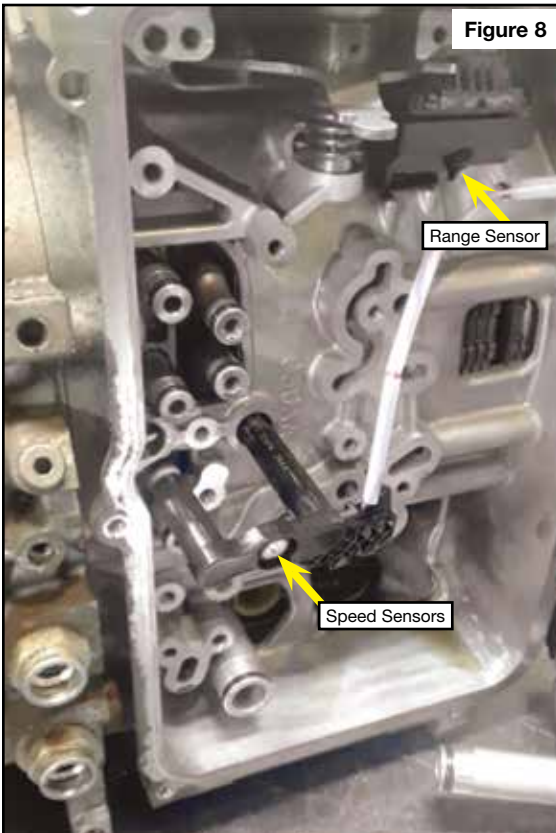
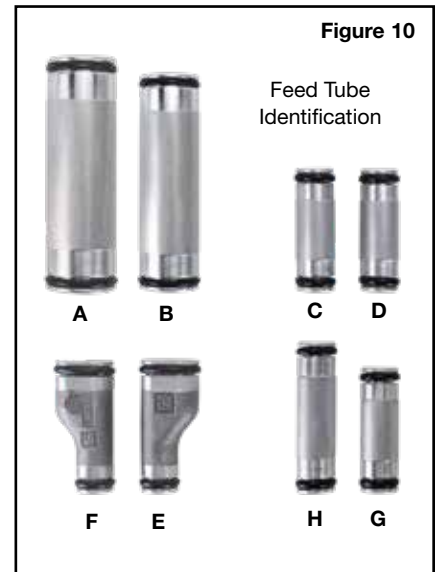
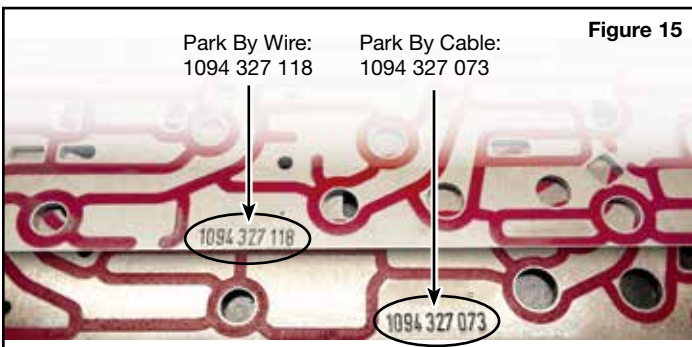
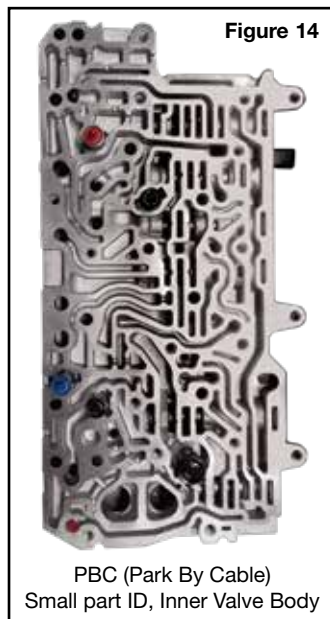
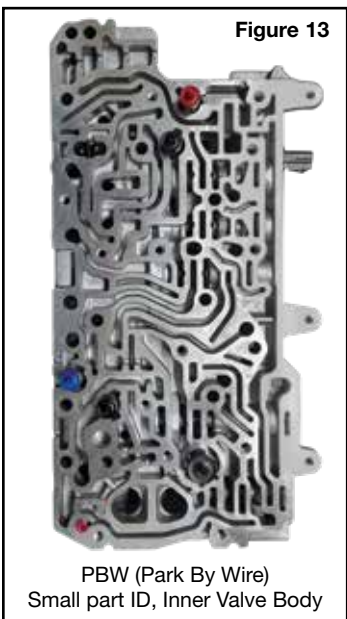
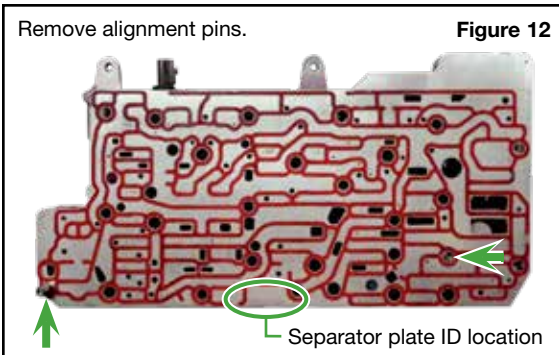
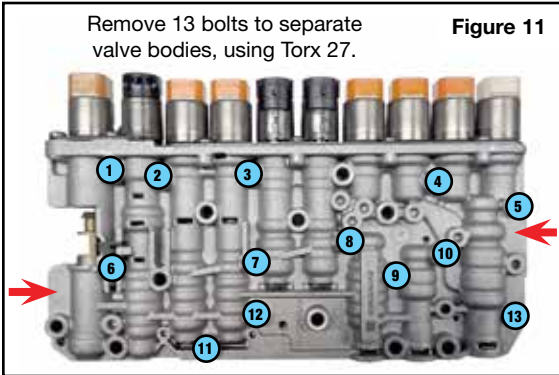

Figure 10





2. Valve Body Disassembly (continued)

- b. Remove the thirteen 27 Torx bolts (**Figure 11**).
- c. Separate the inner valve body from the separator plate and outer valve body.
 - NOTE:** It may be necessary to pry the valve body casting away from the beaded separator plate.
- d. Once the inner valve body has been removed, then remove the beaded separator plate and alignment pins (**Figures 12**).
- NOTE:** Locations for inner valve body small parts differs between PBW and PBC applications (**Figures 13 & 14**).
- e. The separator plate should be replaced with a new one, using the same identification stamping number (**Figures 15**).
- f. Remove four solenoids in outer valve body (**Figures 16 & 17**).

3. Installation

Install Zip Kit parts as shown in diagram of separate quick guide sheet included in this Zip Kit.

Sonnax recommends vacuum testing critical wear areas not covered by this kit to determine whether additional Sonnax parts are required (see pages 5–6).

4. Reassembly

- a. Verify small parts are installed in the correct location based on whether it is a PBC or PBW type valve body (**Figures 12, 13 & 14**).
- b. Reinstall four solenoids into the valve body as well as reinstalling the solenoid retaining bracket and four bolts and torque to 6Nm (53 in-lb) (**Figures 16**).
- c. Verify the alignment pins are in the right location (**Figures 12**).

NOTE: The smaller diameter goes into the inner valve body first.

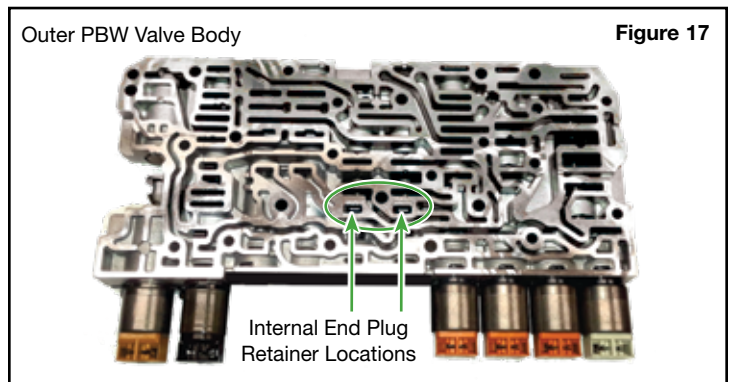
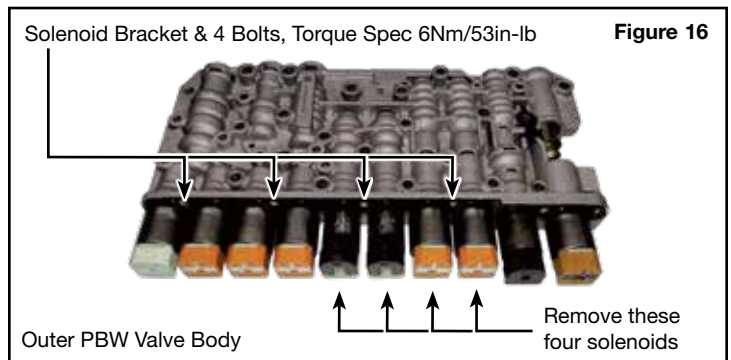

4. Reassembly (continued)

- d. Install separator plate onto the inner valve body over top of the check valves and springs (**Figure 12**).
- e. Install outer valve body over the alignment pins until it is flush with the separator plate.
- f. Install the thirteen 27 Torx bolts and torque to 6Nm (53 in-lb) (**Figure 11**).
- g. Flip valve body assembly over and install wire harness over the solenoid terminals. Install the three 27 Torx retaining bolts and torque to 5.7Nm (50 in-lb) (blue arrows) (**Figure 9**).
- h. Install the 8 feed tubes into the locations shown with the red arrows (**Figures 9 & 10**). Plug in the harness connector for the Dog pressure switch as shown with the green arrow.
- i. Once the tubes are installed into the valve body lubricate the O-rings where they will be installed into the case.

5. Valve Body Reinstall Into Case

- a. Install the range sensor and secure with 27 Torx bolt. Install the input and output sensors and secure with 27 Torx bolt. Torque both of these bolts to 5.7Nm (50 in-lb) (**Figure 18**).
- b. Before installing the valve body onto the case be sure that the wiring harness sits in the area with the dashed line so the harness does not get pinched (**Figure 18**).
- c. Install the valve body onto the case, while guiding the linkage arm into the park cylinder as shown with the blue arrow (**Figure 19**).



NOTE: It may be necessary to apply gentle force when mounting the valve body to the case as the O-rings on the tubes may create some resistance.

- d. Install the ten 40 Torx bolts (light blue arrows) and torque to 8Nm (71 in-lb) (**Figure 19**).
- e. Install the harness connector into the front valve body cover and install the cover onto the case. Install the seven 40 Torx bolts and torque to 9.5Nm (84 in-lb) (**Figure 20**).

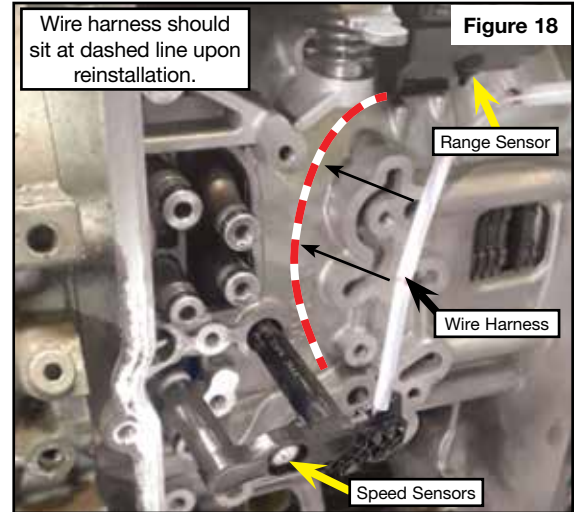

Figure 18

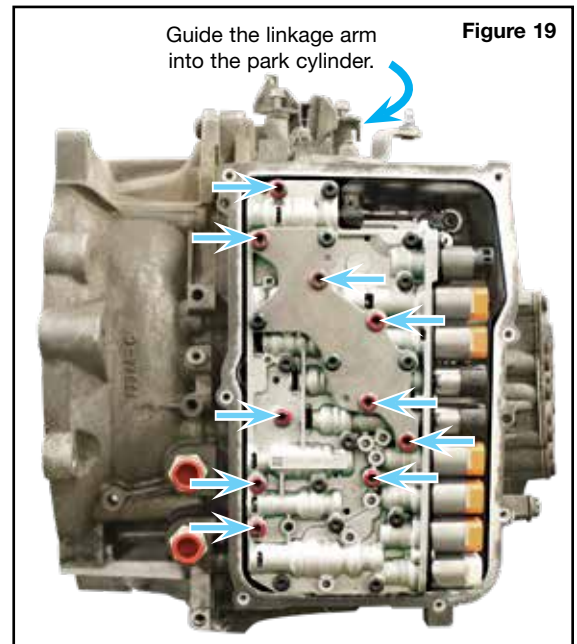

Figure 19

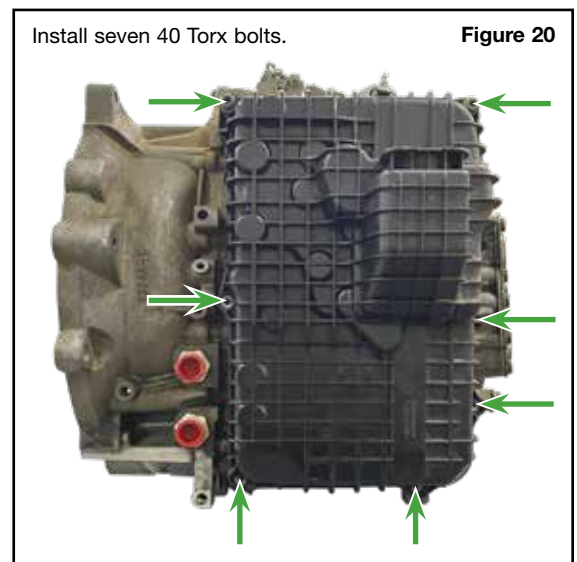

Figure 20

Critical Wear Areas & Vacuum Test Locations



NOTE: OE valves are shown in rest position and should be tested in rest position unless otherwise indicated. Test locations are pointed to with an arrow. Springs are not shown for visual clarity. Low vacuum reading indicates wear and Sonnax parts are noted for replacement.

PBC (Park by Cable) Valve Bodies

• 948TE Shown

Part numbers with an asterisk () are included in this Zip Kit.



For specific vacuum test information, refer to individual part instructions included in kits and available at www.sonnax.com.

F Dog Clutch Plunger Valve

- Loss of higher gears
- Damaged F dog clutch

Replace with Sonnax Part No. 85740-05K*

E Clutch Valve (CV-E)

- No 3-4
- Gear ratio errors
- Loss of higher gears

Lockup Clutch Valve (LC-V)

- TCC slip codes
- Overheating
- TCC lining failure

System Pressure Valve (SP-V)

- Low line pressure
- High line pressure
- Harsh shifts/downshifts

Replace with Sonnax Part No. 85740-15K Requires F-85740-TL15 & VB-FIX

Limp Home Valve

- 4th Gear starts
- Stuck in limp mode

B Clutch Valve (CV-B)

- No Reverse • 2-3 Flare
- No 5th • Gear ratio errors

Solenoid Pressure Regulator Valve (PR-V)

- Solenoid performance codes
- Low solenoid feed pressure

Replace with Sonnax Part Nos. 85740-09K* or 85740-11K Requires F-68942-TL14 & VB-FIX

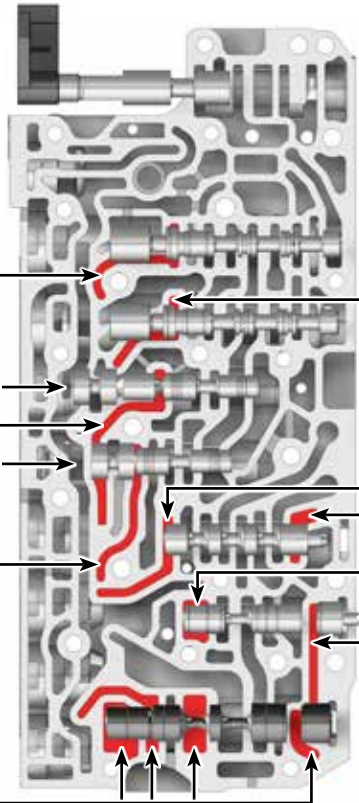

Upper Valve Body

A Dog Clutch Plunger Valve

- Loss of higher gears
- Damaged A dog clutch

Replace with Sonnax Part No. 85740-05K*

Converter Switch Valve (SP-V)

- TCC slip codes • TCC lining failure
- TCC apply & release codes

Lubrication Valve (LU-V)

- Low cooler flow
- Overheating
- Low converter & lube flow

End Plugs

- Soft shifts • Flare shifts • Harsh shifts
- Burnt Clutches
- Pressure Loss

Replace with Sonnax Part No. 85740-01K*
End Plugs (4) = ⊙ Internal End Plugs (2) = ◇

C Clutch Valve (CV-C)

- 1-2 Flare
- No 6th
- Gear ratio errors

D Clutch Valve (CV-D)

- No Forward • No Reverse
- Loss of higher gears
- Reverse slip • Forward slip

Shift Valve System Pressure (SV-SP)

- Poor line pressure control
- Poor shift quality
- Gear ratio errors

Replace with Sonnax Part No. 85740-07K*

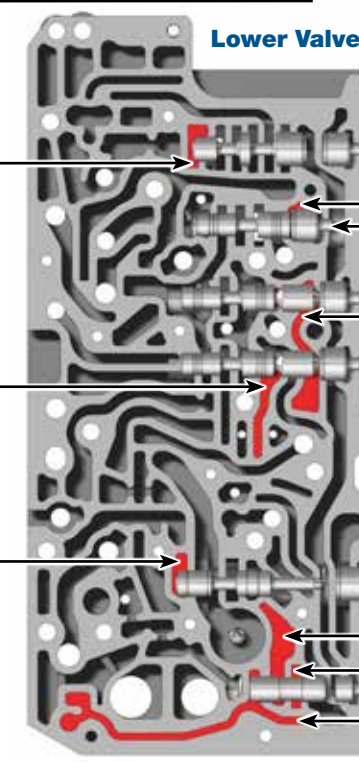

Lower Valve Body

Critical Wear Areas & Vacuum Test Locations



NOTE: OE valves are shown in rest position and should be tested in rest position unless otherwise indicated. Test locations are pointed to with an arrow. Springs are not shown for visual clarity. Low vacuum reading indicates wear and Sonnax parts are noted for replacement.

PBW (Park by Wire) Valve Bodies
• 948TE Shown



For specific vacuum test information, refer to individual part instructions included in kits and available at www.sonnax.com.

Part numbers with an asterisk () are included in this Zip Kit.

F Dog Clutch Plunger Valve

- Loss of higher gears
- Damaged F dog clutch

Replace with Sonnax Part No. 85740-05K*

E Clutch Valve (CV-E)

- No 3-4
- Gear ratio errors
- Loss of higher gears

B Clutch Valve (CV-B)

- No Reverse
- 2-3 Flare
- No 5th

System Pressure Valve (SP-V)

- Low line pressure
- High line pressure
- Harsh shifts/downshifts

Replace with Sonnax Part No. 85740-15K Requires F-85740-TL15 & VB-FIX

D Clutch Valve (CV-D)

- No Engagement
- Slips in Reverse & 1st
- Loss of higher gears

Lockup Clutch Valve (LC-V)

- TCC slip codes
- Overheating
- TCC lining failure

Solenoid Pressure Regulator Valve (PR-V)

- Solenoid performance codes
- Low solenoid feed pressure

Replace with Sonnax Part Nos. 85740-09K* or 85740-11K Requires F-68942-TL14 & VB-FIX

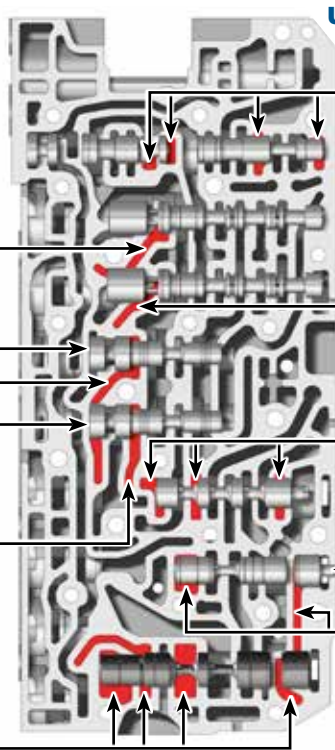

Upper Valve Body

Park Cylinder Valves 1 (PCV-1) & 2 (PCV-2)

- Park position release & apply concerns

A Dog Clutch Plunger Valve

- Loss of higher gears
- Damaged A dog clutch

Replace with Sonnax Part No. 85740-05K*

Converter Switch Valve (SP-V)

- TCC slip codes • TCC lining failure
- TCC apply & release codes

Lubrication Valve (LU-V)

- Low cooler flow
- Overheating
- Low converter & lube flow

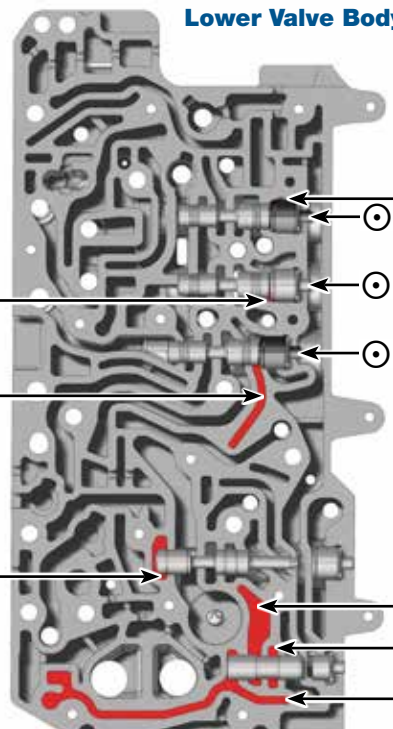

Lower Valve Body

End Plugs

- Soft shifts • Flare shifts • Harsh shifts
- Burnt Clutches
- Pressure Loss

Replace with Sonnax Part No. 85740-01K*

End Plugs (4) = Internal End Plugs (2) =

C Clutch Valve (CV-C)

- 1-2 Flare
- No 6th
- Gear ratio errors

Shift Valve System Pressure (SV-SP)

- Poor line pressure control
- Poor shift quality
- Gear ratio errors

Replace with Sonnax Part No. 85740-07K*

OE Exploded View

Outer Valve Body • 948TE, PBC Shown

NOTE: Depending upon vehicle application, the OE springs shown may not be present.

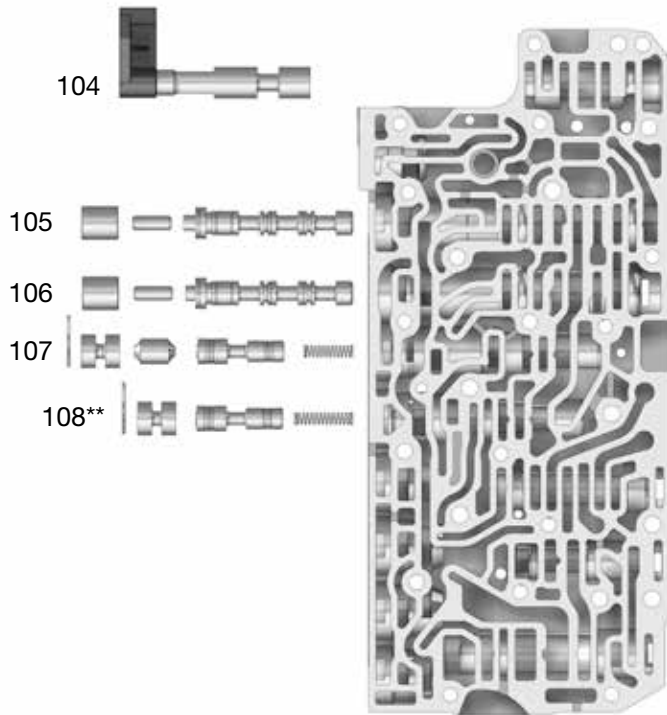

Upper Valve Body Descriptions

I.D. No.	Description
101	Converter Switch Valve (SP-V)
102	Lubrication Valve (LU-V)
103	System Pressure Valve (SP-V)
104	Manual Valve
105	F Dog Clutch Valve (CV-F)
106	A Dog Clutch Valve (CV-A)
107	E Clutch Valve (CV-E)
108	Lockup Clutch Valve (LC-V)**

** Valve location is different between PBC and PBW

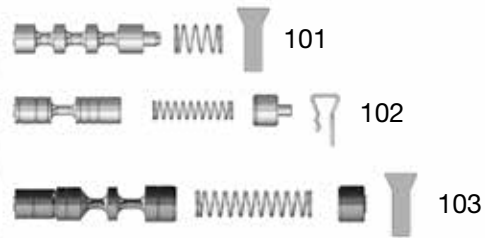

Lower Valve Body • 948TE, PBC Shown

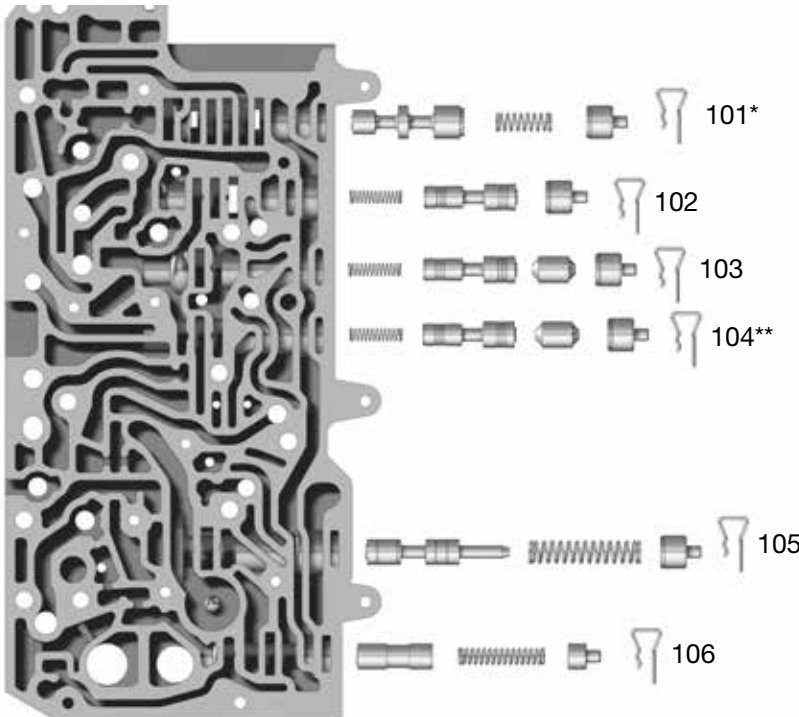

Upper Valve Body Descriptions

I.D. No.	Description
101	Limp Home Valve*
102	C Clutch Valve (CV-C)
103	D Clutch Valve (CV-D)
104	B Clutch Valve (CV-B)**
105	Solenoid Pressure Regulator Valve (PR-V)
106	Shift Valve System Pressure (SV-SP)

* PBW does not have this valve.

** Valve location is different between PBC and PBW

OE Exploded View

Outer Valve Body • 948TE, PBW Shown

NOTE: Depending upon vehicle application, the OE springs shown may not be present.

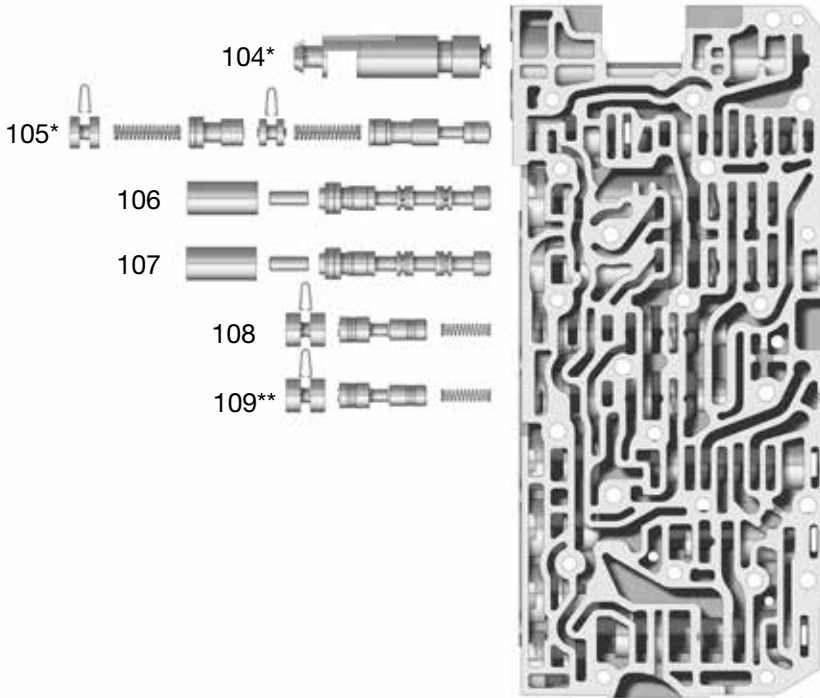

Upper Valve Body Descriptions

I.D. No.	Description
101	Converter Switch Valve (SP-V)
102	Lubrication Valve (LU-V)
103	System Pressure Valve (SP-V)
104	Park Cylinder (PCYL)*
105	Park Cylinder Valve (PCV-1, -2)*
106	F Dog Clutch Valve (CV-F)
107	A Dog Clutch Valve (CV-A)
108	E Clutch Valve (CV-E)
109	B Clutch Valve (CV-B)**

* PBC does not have this valve.

** Valve location is different between PBC and PBW

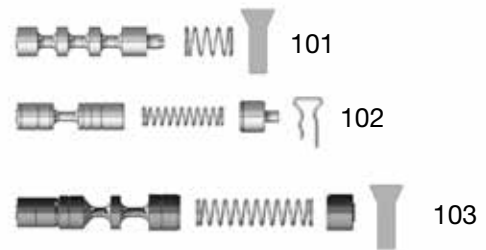

Lower Valve Body • 948TE, PBW Shown

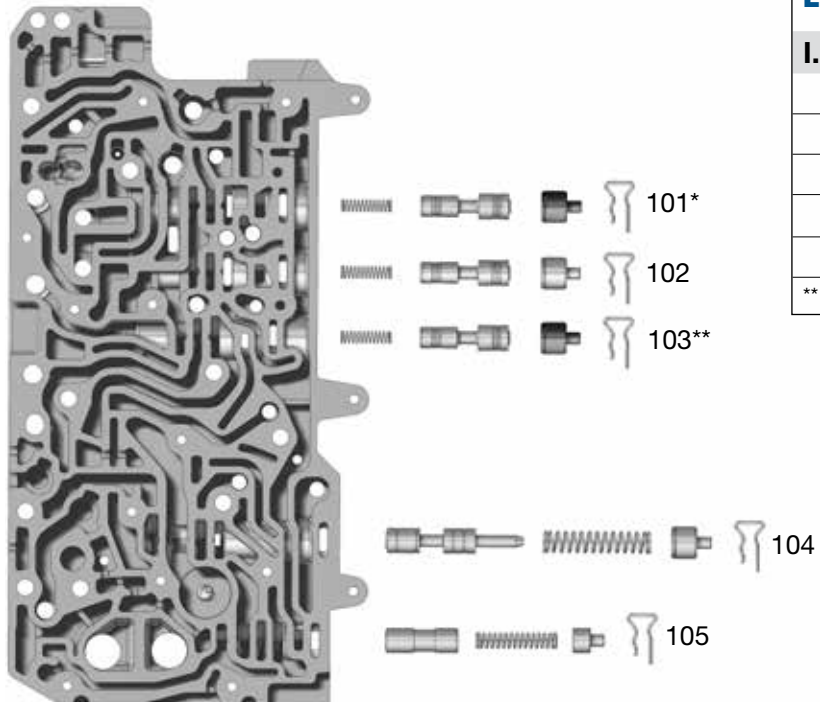

Lower Valve Body Descriptions

I.D. No.	Description
101	C Clutch Valve (CV-C)
102	D Clutch Valve (CV-D)
103	Lockup Clutch Valve (LC-V)**
104	Solenoid Pressure Regulator Valve (PR-V)
105	Shift Valve System Pressure (SV-SP)

** Valve location is different between PBC and PBW