

Oversized Lockup Timing Valve Kit



Part No.
98892-22K

- Valve 3 Large Spools
- End Plug

NOTE: Verify the OE valve configuration matches the Sonnax replacement valve for proper installation (see illustration).

This kit fits various Honda 4/5 speed models. However, model to model, the appearance of valve bodies and the location of the lockup timing valve may vary. The BVGA '03-'07, 3.5L Pilot model is illustrated here. See Honda **98892-22K** and **98892-24K** Application Chart for a detailed guide.

Tool Kit



Part No.
F-98892-TL22

- Reamer
- Reamer Jig
- Guide Pin

NOTE: This tool kit is used for both **98892-22K** & **98892-24K**.

Sonnax "F-Tool" kits designed to service a specific bore require the VB-FIX, a self-aligning valve body reaming fixture. More information and instructions can be found online at www.sonnax.com.

Also Available

Oversized Lockup Timing Valve Kit

98892-24K 2 Large Spools

Honda/Acura 4-Speed, 3 Shaft, 5-Speed

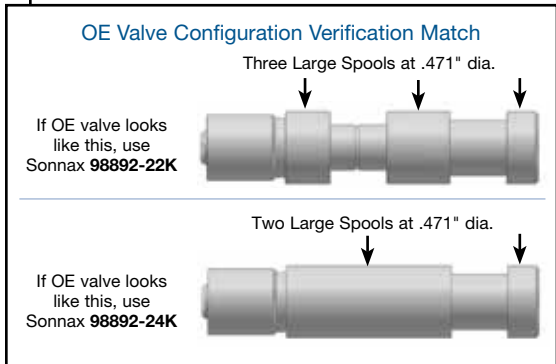
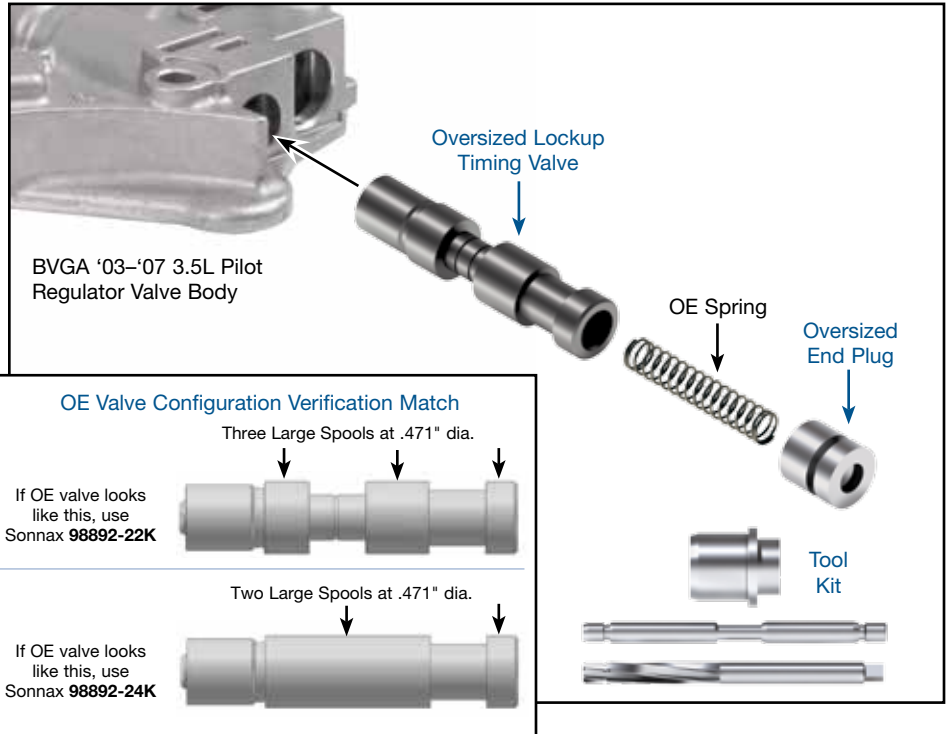

Honda 4/5-Speed 98892-22K & 98892-24K Application Chart

Make	Model	Year		Trans. Code
		From	To	
Acura	3.0CL	1996	2000	M7ZA
Acura	3.0CL	1997	2000	B7ZA
Acura	3.2CL	2001	2006	BGFA
Acura	3.2CL	2001	2006	MGFA
Acura	3.2TL	1999	1999	B7VA
Acura	3.2TL	2000	2003	M7WA
Acura	3.2TL	2001	2003	B7WA
Acura	MDX	2001	2002	BGHA
Acura	MDX	2001	2002	MGHA
Acura	TL	2004	2008	BDGA
Honda	Accord	1998	2002	B7XA
Honda	Accord	2003	2007	BAYA
Honda	Accord	2003	2007	MAYA
Honda	Odyssey	1999	2001	B7TA
Honda	Odyssey	1999	2001	B7YA
Honda	Odyssey	2002	2004	BYBA
Honda	Odyssey	2005	2007	BGRA
Honda	Odyssey	2005	2007	PGRA
Honda	Pilot	2003	2007	BVGA
Honda	Pilot	2003	2007	BVLA
Honda	Pilot	2003	2007	PVGA
Honda	Pilot	2003	2007	PVLA

1. Disassembly

- Remove all OE components from the bore
- Keep the OE valve spring and the end plug retaining clip for reuse. Discard valve and end plug.

2. Reaming

- Ream lockup timing bore (for reaming instructions/reamer care, please visit www.sonnax.com). Sonnax reaming tool kit **F-98892-TL22** and **VB-FIX** are required for this operation.
- Thoroughly clean valve bore and body after reaming.

3. Installation & Assembly

- Insert the Sonnax lockup timing valve with the spring pocket outboard.
- Insert the OE spring into the valve spring pocket.
- Insert the Sonnax end plug and secure it in position with the OE retainer.

4. Final Testing

Vacuum testing at the port(s) indicated holds the recommended minimum 14 in-Hg and 18 in-Hg.

