



Clutch Plate

Part No.

ZF-CP-13

ZF6HP19, 245mm (LuK)



Installation Instructions Option A: Rotary Cutting Wheel Tool

1. Disassembly

- a. Remove OE clutch plate damper assembly from OE torque converter core.
- b. Remove two of the three plates securing the clutch plate to the damper. Each of these plates are attached with four square rivets (**Figure 1**).
 1. Remove plates by removing material from the sides of the four rivets with a rotary cutting wheel tool (**Figure 2**). Finish up with a file (**Figure 3**).
 2. Do NOT remove material off the top of rivets as it is necessary to provide enough material to re-peen the head of the rivet back into place after installing Sonnax clutch plate **ZF-CP-13**.



CAUTION: Only remove two of the three plates.

3. Remove only enough material from the rivet sides to be able to remove the plates. Removing additional material could compromise the ability to re-peen the rivet heads. It may be necessary to use a hammer to slightly tap the clutch plate to remove these plates (**Figure 4**).

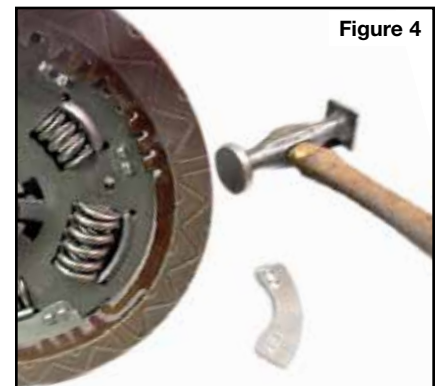
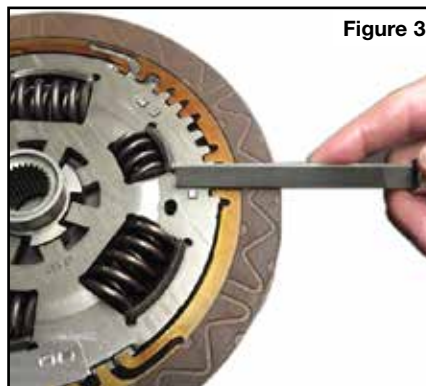
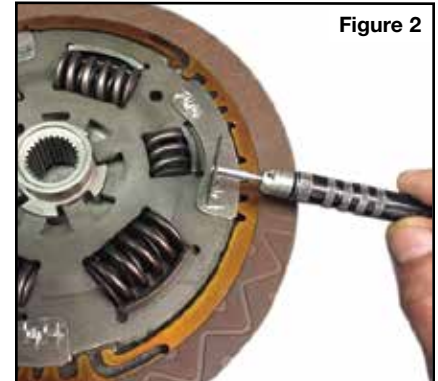
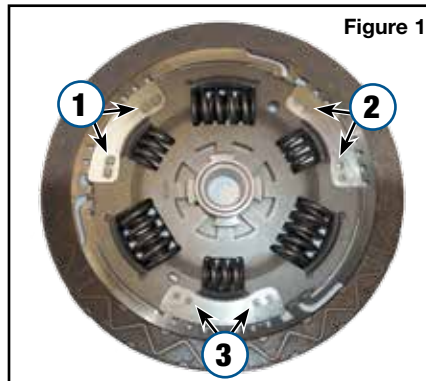



TORQUE CONVERTER PARTS

CLUTCH PLATE ZF-CP-13

Instructions

1. Disassembly continued

- c. Once two of the three plates are detached (Figure 5), remove OE clutch plate (Figure 6).



NOTE: It takes some practice to remove the OE clutch plate from the damper. Start by lifting clutch plate at a diagonal across from the still secured plate (Figure 7).

2. Installation

- a. Assemble Sonnax clutch plate ZF-CP-13 to OE damper by aligning the two fingers shown (Figure 8) and attaching to the right of the third and still secured plate.
- b. Turn the two OE plates over and replace them back in their original positions, sliding them over the modified rivets (Figure 9).
- c. Clamp the entire assembly together to make sure there are no gaps. Once secure,peen down the 8 rivets (4 from each of the 2 plates removed), (Figure 10).
- d. Newly peened rivets should be welded for best results. Clamp down on plates to hold into place for welding (Figure 11).
- e. Once in place, weld tops of eight rotary cut rivets (Figure 12).



CAUTION: Distortion of plates can occur if welding process becomes too hot.

- f. Check the clutch plate damper assembly, removing any loose or excess material. Assembly is ready to re-assemble into OE torque converter core (Figure 13).

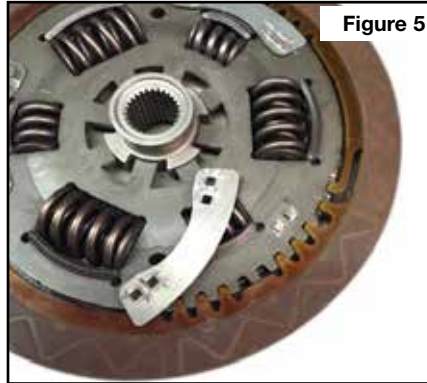

Figure 5

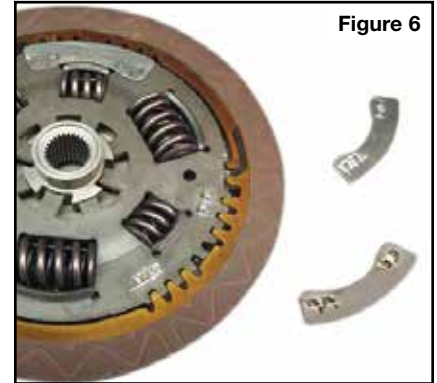

Figure 6

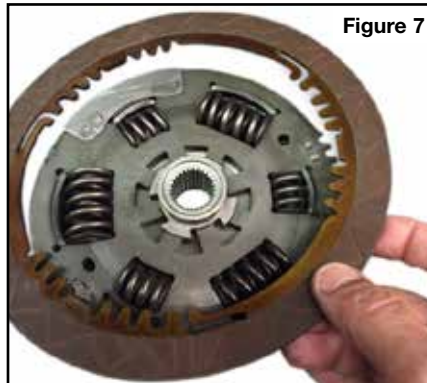

Figure 7

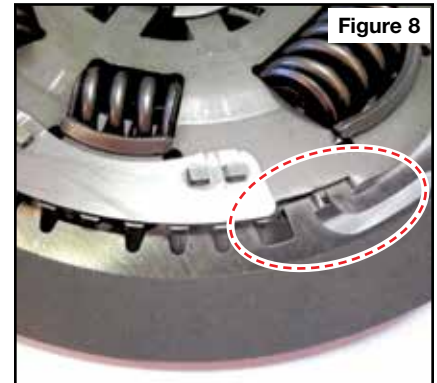

Figure 8

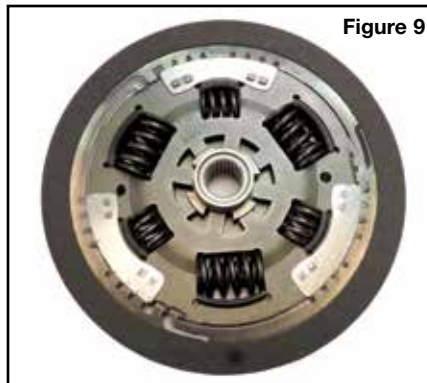

Figure 9

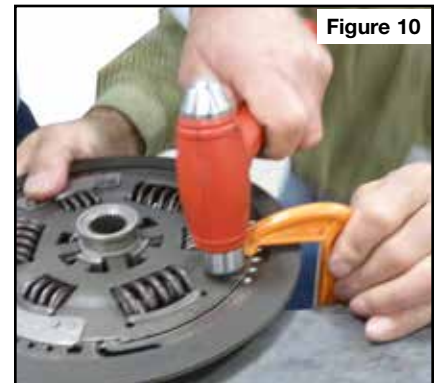

Figure 10

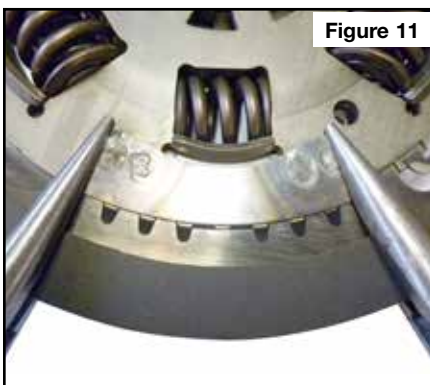

Figure 11

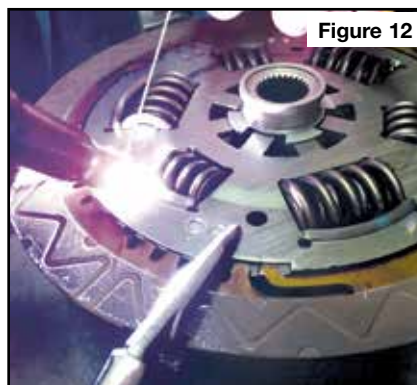

Figure 12

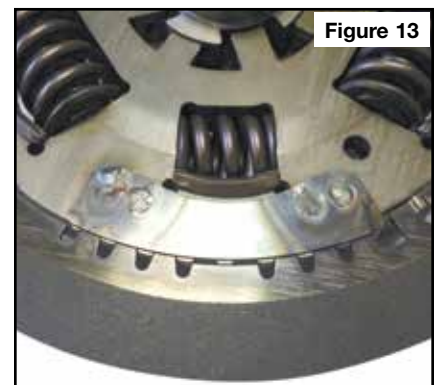

Figure 13



Installation Instructions Option B: Milling Machine

1. Disassembly

- Remove OE clutch plate damper assembly from OE torque converter core.
- Remove two of the three plates securing the clutch plate to the damper (**Figure 1**). Each of these plates are attached with four rivets. Remove rivets by milling the material off the tops (**Figure 2**). Finish with a file if needed (**Figure 3**).

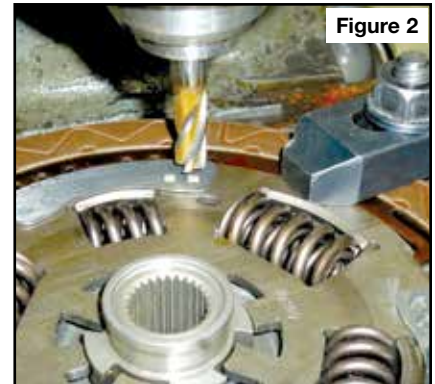
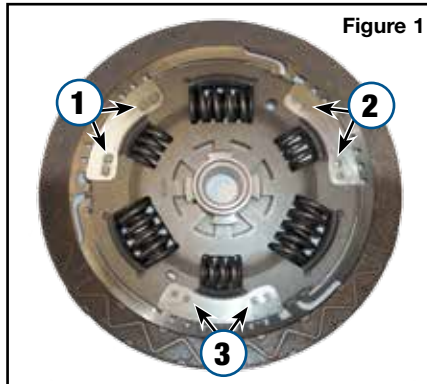

CAUTION: Only remove two of the three plates.

- It may be necessary to use a hammer to slightly tap the clutch plate to remove these plates (**Figure 4**).
- Once two of the three plates are detached (**Figure 5**), remove OE clutch plate (**Figure 6**).

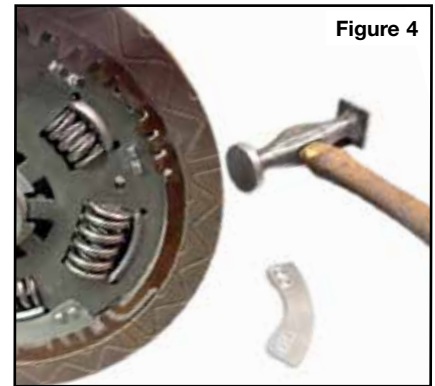
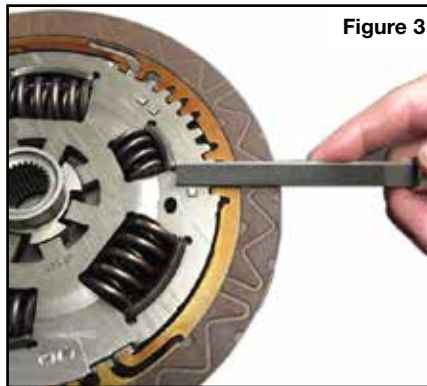

NOTE: It takes some practice to remove the OE clutch plate from the damper. Start by lifting clutch plate at a diagonal across from the still secured plate (**Figure 6**).

2. Installation

- Assemble Sonnax clutch plate ZF-CP-13 to OE damper by aligning the two fingers shown (**Figure 7**) and attaching to the right of the third and still secured plate.
- Turn the two OE plates over and replace them back in their original positions, sliding them over the modified rivets (**Figure 8**).
- Clamp the entire assembly together to make sure there are no gaps.
- Once in place, weld tops of the eight milled rivets (**Figures 9 & 10**).

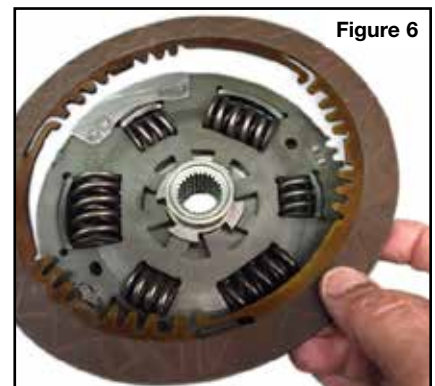
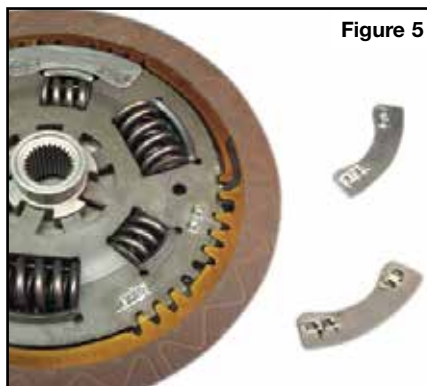

CAUTION: Distortion of plates can occur if welding process becomes too hot.

- Check the clutch plate damper assembly, removing any loose or excess material. Assembly is ready to re-assemble into OE torque converter core (**Figure 11**).

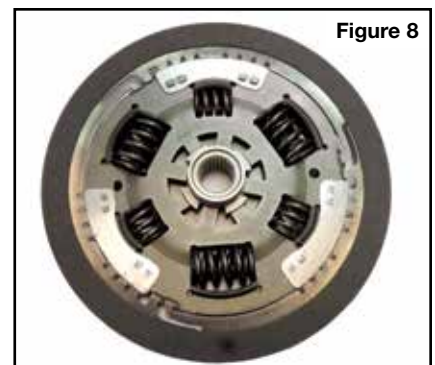
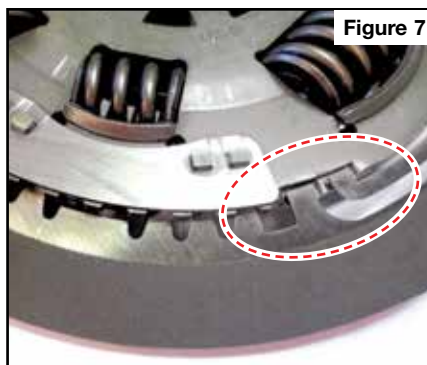



TORQUE CONVERTER PARTS

CLUTCH PLATE ZF-CP-13

Instructions

2. Installation continued

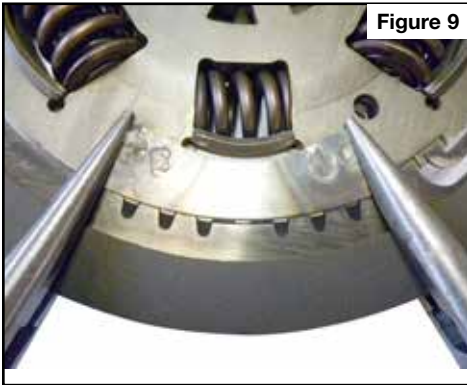

Figure 9

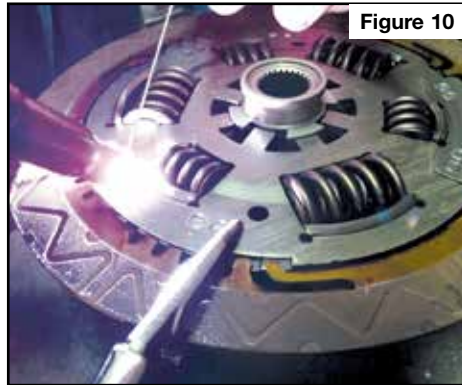

Figure 10



Figure 11